

Number **1**  
 Date **APRIL 15, 1982**  
 Page **1** of **4**

Models Affected: **ADVANTAGE**      Class of Change: **MANDATORY**  
 Assembly(s) Affected: **ADV BASE ASSY**      Field Action: **INSTALL ON NEXT CALL**  
 Factory Implementation: **5-1-82**      Est. Install. Time: **0.5** Hrs.

**1. REASON FOR CHANGE**

Provide adequate grounding between I/O plate, AC power panel and chassis of Advantage Computer. This change is mandatory to conform to UL & CSA standards. Without this modification, equipment could be damaged under certain short circuit conditions.

**2. DESCRIPTION OF CHANGE**

Grounding is accomplished by adding one (1) wire between the AC power panel (North Star P/N 00359) and the I/O plate (North Star P/N 00356) and one (1) wire between the AC power panel and the disk drive bracket (North Star P/N 00352).

**3. REVISION IDENTIFICATION**

N/A

**4. REWORK INSTRUCTIONS**

Installation instructions are attached to this document and are also included in the Advantage Grounding Retrofit Kit (North Star P/N 02210)

**5. CHECKOUT PROCEDURE**

Checkout procedures are included in the installation instructions mentioned in item 4 above.

**6. TOOLS REQUIRED**

A list of all tools required to perform this modification are included in the installation instructions mentioned in item 4 above.

1—Reason for change   2—Description of change   3—Revision ID   4—Rework instructions   5—Checkout procedure   6—Tools required  
 7—Parts required   8—Effect on spares   9—Documentation affected   10—Software affected   11—Attachments

APPROVED	DATE	SUPERSEDES	DATED	VERIFIED BY	DATE

7. PARTS REQUIRED

Order Advantage Grounding Retrofit Kit, North Star Part Number 02210 from your North Star Sales Administrator. Kits will be shipped free of charge. You must supply serial numbers for all Advantages requiring this change.

8. EFFECT ON SPARES

None

9. DOCUMENTATION AFFECTED

None

10. SOFTWARE AFFECTED

None

11. ATTACHMENTS

Instructions for installing the Advantage Grounding Retrofit Kit (North Star P/N 02210) are attached.

# ADVANTAGE GROUNDING RETROFIT INSTRUCTIONS

## TOOLS REQUIRED:

1. Medium Phillips screwdriver
2. Medium standard flat blade screwdriver
3. 1/4" socket or open end wrench

## CHECK PARTS:

This Kit should contain the following parts:

<u>ITEM</u>	<u>QTY</u>	<u>PART NUMBER</u>	<u>DESCRIPTION</u>
1	1	02211	Wire, 18 awg, 15" w/#6 ring lug at each end
2	1	02206	Wire, 18 awg, 7" w/#6 ring lug at each end
3	2	38002	Lockwasher, #6 int. tooth
4	2	38010	Nut, 6-32
5	1	38082-12	Screw, 6-32x3/4" pan head-xrecess

Should any of the parts listed above be missing, please contact your dealer for assistance.

## INSTALLATION INSTRUCTIONS

1. Disconnect the Advantage from the AC power source.
2. Remove the top cover of the Advantage as described in Section 6.5.2 of the Advantage Technical Manual (North Star P/N 00464).
3. Using Figure 1 as a reference, remove screw A on the AC power panel. (NOTE: this screw already secures two (2) wires, one solid green 24 awg wire going to the main PCB connector and one green/yellow 18 awg wire going to the power transformer).

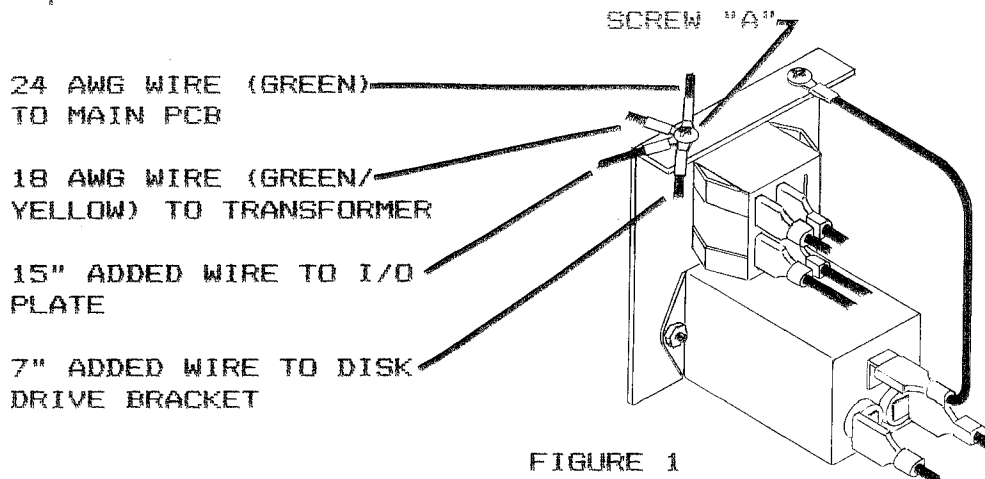

FIGURE 1

4. Attach one end of each of the two wires supplied in the kit to the screw removed in step 3 along with the two wires already attached to the screw and replace the screw on the AC power panel.
5. Using Figure 2 as a reference, remove screw A on the I/O mounting panel. Discard this screw.

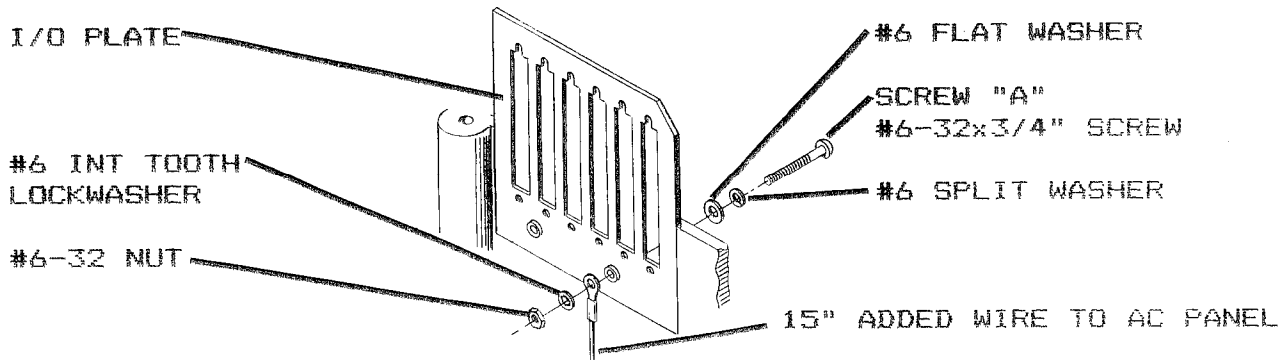

FIGURE 2

6. Using the hardware supplied in the kit, install the loose end of the 15" wire to the I/O mounting plate as shown in Figure 2.
7. Using Figure 3 as a reference, remove screw A on the disk drive mounting bracket.

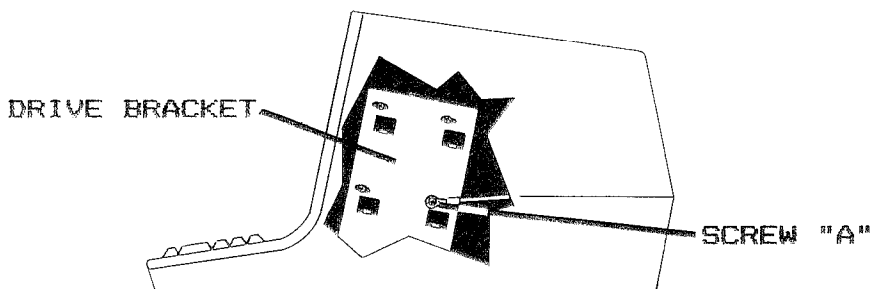

FIGURE 3

8. Connect the loose end of the 7" wire to the drive mounting bracket using the screw removed in step 7.
9. Using a DVM, check to make certain that there is zero ohms between the I/O mounting panel, the disk drive bracket and the AC power panel.
10. Replace the Advantage top cover as described in Section 6.5.2 of the Advantage Technical Manual.

Number 1  
 Date APRIL 1, 1982  
 Page 1 of 3

North Star Computers, Inc. is pleased to announce that effective immediately, all Authorized Dealers, Distributors and OEMs will begin receiving Technical Bulletins and Field Change Notices from North Star. In fact, this document is TECHNICAL BULLETIN #1!!!

Technical Bulletins will be written in a free-style prose format, issued on an as needed basis and cover such subjects as: new service program announcements; revisions to parts lists; pricing changes; software revisions; service hints; and answers to questions posed most often to our Hot Line personnel.

Field Change Notices, (FCNs), will be issued whenever North Star or one of its OEM suppliers makes a change to one of its products which effects the form, fit, or function of the equipment. Unlike Technical Bulletins, the format of FCNs is very structured. Every FCN will conform to the following format:

- o The upper section of the first page of an FCN will contain: the FCN Number; Issue Date; the Number of Pages; what Model(s) are Affected (ie., HRZ 20-64K); what Assembly(s) are Affected (ie., HRAM-64k - P/N 00128-01); expected date of Factory Implementation; the Class of the FCN (ie., MANDATORY, PRODUCT IMPROVEMENT, COST REDUCTION, etc.); what Field Action is recommended; and the Estimated Time it will take to field Install the FCN.
- o The main body of the FCN will always detail the following information in the same order:
  1. Reason for the change.
  2. Description of the change.
  3. Revision identification information.

APPROVED	DATE	SUPERSEDES	DATED	VERIFIED BY	DATE

4. Rework instructions, if any.
5. Checkout procedure to ensure proper installation of the FCN.
6. Tools required to install FCN, if any.
7. Parts required including pricing and ordering information if applicable.
8. Effect on current distributed spare parts, if any.
9. Effect on current distributed documentation, if any.
10. Effect on current distributed software, if any.
11. Attachments, if any. Attachments include new schematics, addendum information if any documentation is effected, etc.

o You will find a blank FCN form attached to this document.

We at North Star hope you find the Technical Bulletin and Field Change Notice Program an asset to your service group.



# Field Change Notice

Number \_\_\_\_\_  
Date \_\_\_\_\_  
Page \_\_\_\_\_ of \_\_\_\_\_

Models Affected:

Class of Change:

Assembly(s) Affected:

Field Action:

Factory Implementation:

Est. Install. Time:

Hrs.

1—Reason for change 2—Description of change 3—Revision ID 4—Rework instructions 5—Checkout procedure 6—Tools required 7—Parts required 8—Effect on spares 9—Documentation affected 10—Software affected 11—Attachments

APPROVED	DATE	SUPERSEDES	DATED	VERIFIED BY	DATE

Number 2  
 Date APRIL 1, 1982  
 Page 1 of 5

SPARE PARTS LISTS

REVISION 4/1/82

Please find attached a SPARE PARTS LIST for North Star's HORIZON(R), ADVANTAGE, HD-18 and HD-5 Product Lines.

These Parts Lists provide North Star Part Number, Part Description, Suggested Retail Price and the Suggested Stocking Levels for 25, 100 and 500 installed units.

Prices quoted are those in effect as of April 1, 1982 and are subject to change. Please contact your North Star Sales Administrator or Authorized North Star Distributor for appropriate discounts.

This Technical Bulletin supersedes a Dealer Letter dated 12/21/81 on the same subject.

APPROVED	DATE	SUPERSEDES	DATED	VERIFIED BY	DATE



MAJOR SPARE PARTS LIST (INCLUDES STOCKING LEVELS) FOR HORIZON  
 LAST FILE UPDATE - 4 - 1 - 1982

PART #	DESCRIPTION	SUGGESTED RETAIL PRICE	NUMBER OF SPARES REQUIRED TO SUPPORT		
			25	100	500
00128-01	PCB, HRAM 64K	699.00	2	3	9
00128-02	PCB, HRAM 48K	599.00	2	3	9
00128-03	PCB, HRAM 32K	499.00	2	3	9
00134	PCB, HSIO-4	349.00	2	3	9
00152	PCB, HD-5 CONTR, HRZ	243.78	2	3	9
00580	DRIVE, HD-5 (GENERIC)	2,995.00	2	3	9
08006	PCB, MOTHERBOARD, HRZ	473.00	2	2	5
08008	PCB, FPB-A ASM	399.00	2	3	9
08009	PCB, MDS-D ASM.	565.00	2	3	9
08014	PCB, ZPB ASM.	325.00	2	3	9
28018B	COVER, HRZ, METAL, BEIGE	91.27	2	2	5
28019	COVER, HRZ, WOOD	85.27	2	2	3
31001	FAN, ETRI	43.43	2	3	9
43078	IC, PROM MDS DSEL, HRZ	15.46	2	2	3
43079	IC, PROM MDS DWE, HRZ/ADV	15.46	2	2	3
43080	IC, PROM MDS LE-8, HRZ	7.27	2	2	3
43081	IC, PROM MDS RE-8, HRZ	7.27	2	2	3
43082	IC, PROM MDS SE-8, HRZ	7.27	2	2	3
43083	IC, PROM FPB ACSP-3, HRZ	13.96	2	2	3
43084	IC, PROM FPB ASRP-3, HRZ	13.96	2	2	3
43085	IC, PROM FPB BALP-3, HRZ	13.96	2	2	3
43086	IC, PROM FPB BAMP-3, HRZ	13.96	2	2	3
43087	IC, PROM FPB BCSP-3, HRZ	13.96	2	2	3
43088	IC, PROM BSCP-3, HRZ	13.96	2	2	3
43089	IC, PROM FPB CADP-3, HRZ	13.96	2	2	3
43090	IC, PROM FPB CCOP-3, HRZ	13.96	2	2	3
43091	IC, PROM FPB COMP-3, HRZ	13.96	2	2	3
43092	IC, PROM FPB MSCP-3, HRZ	13.96	2	2	3
43093	IC, PROM FPB STOP-3, HRZ	13.96	2	2	3
43094	IC, PROM 6309 DPGM, HRZ	22.05	2	2	3
43142	IC, PROM VTIM, HRZ/ADV	13.96	2	2	3
43143	IC, PROM VTIM50, HRZ/ADV	13.96	2	2	3
43160	IC, PROM MHDWP, HRZ/ADV	8.62	2	2	3
49001	DRIVE, SHUGART SA, 400	520.00	2	3	9
49002	DRIVE, TANDON TM-102	750.00	2	3	9
68007	SWITCH, POWER, HRZ/ADV	4.45	2	3	9
74008	TRANSFORMER, HRZ-CUSTOM	94.53	2	2	5
77043	CORD, POWER	9.26	2	2	5
77064	CABLE, 3RD DRIVE HRZ.	50.51	2	2	3
77095	CABLE, DRIVE POWER, HRZ	3.32	2	2	5

MAJOR SPARE PARTS LIST (INCLUDES STOCKING LEVELS) FOR ADVANTAGE  
 LAST FILE UPDATE - 4 - 1 - 1982

PART #	DESCRIPTION	SUGGESTED RETAIL PRICE	NUMBER OF SPARES REQUIRED TO SUPPORT		
			25	100	500
00102	PCB, MAIN ASSY, ADV	2,500.00	2	5	15
00113	PCB, SID ASSY, ADV	175.00	2	5	15
00117	IC, PROM, 2716-1 BOOT, ADV	24.00	2	2	3
00145	IC, PROM, 2716 F-KYBD, ADV	24.00	2	2	3
00148	PCB, PID ASSY, ADV	200.00	2	5	15
00154	TRANSFORMER, POWER, ADV	77.53	2	3	9
00157	PCB, HDS CONTR, ADV	212.85	2	3	9
00333	CABLE, DRV POWER, ADV	13.22	2	3	9
00334	HARNESS, POWER, DRIVE, ADV	9.48	2	3	9
00335	CABLE, SIG, DRIVE, ADV	45.20	2	3	9
00336	CABLE, MONITOR, ADV	10.42	2	3	9
00355	COVER, BOTTOM, ADV	116.94	2	2	3
00357	KEYBOARD, DOMESTIC, ADV	171.50	2	3	9
00358	CABLE, KYBD, ADV	15.43	2	3	9
00359	PANEL, POWER, ADV	63.68	2	2	5
00365	CRT & VIDEO PCB, ADV	272.22	2	3	9
00366	COVER, TOP, ADV	88.66	2	2	5
00368	PANEL, FRONT, ADV	64.49	2	2	5
00372-01	KNOB, BRIGHTNESS, ADV	4.29	2	2	3
00386	CABLE, SINGLE FLOPPY, ADV	47.00	2	3	9
00399	WIRE, HD-5 GROUNDING, ADV	3.75	2	2	5
00580	DRIVE, HD-5 (GENERIC)	2,995.00	2	3	9
31001	FAN, ETRI	43.43	2	3	9
43079	IC, PROM MDS DWE, HRZ/ADV	15.46	2	2	3
43139	IC, PROM HTIMH, ADV	13.96	2	2	3
43140	IC, PROM HTIML, ADV	13.96	2	2	3
43141	IC, PROM IOSEL, ADV	13.96	2	2	3
43142	IC, PROM VTIM, HRZ/ADV	13.96	2	2	3
43143	IC, PROM VTIM50, HRZ/ADV	13.96	2	2	3
43160	IC, PROM MHDWP, HRZ/ADV	8.62	2	2	3
49002	DRIVE, TANDON TM-102	750.00	2	3	9
68007	SWITCH, POWER, HRZ/ADV	4.45	2	3	9
68018	FUSE, 2A, 20MMx5MM, SLO-BLD	2.16	2	3	9
68019	FUSE, 1A, 20MMx5MM, TIME-LAG	2.16	2	3	9
68020	FUSE, 8A, FAST-BLD	1.64	2	2	5
77043	CORD, POWER	9.26	2	2	5

MAJOR SPARE PARTS LIST (INCLUDES STOCKING LEVELS) FOR HD-18  
 LAST FILE UPDATE - 4 - 1 - 1982

PART #	DESCRIPTION	SUGGESTED RETAIL PRICE	NUMBER OF SPARES REQUIRED TO SUPPORT		
			25	100	500
00220	BELT, DRIVE, (50HZ), HD-18	24.75	2	2	5
00221	BELT, DRIVE (60HZ), HD-18	22.50	2	3	9
00224	CAP, START, (110V), HD-18	21.20	2	2	3
00225	CLIP, CAP MOUNT, (110V), HD-18	6.55	2	2	3
00228	SPRING, SPINDLE GROUNDING, HD18	70.88	2	5	15
00229	MOTOR/BRAKE ASSY (110V), HD-18	608.44	2	3	9
00230	MOTOR/BRAKE ASSY, (220V), HD-18	608.44	2	2	5
00231	RELAYS, K1 AND K2, HD-18	60.38	2	3	9
00232	SCREW, SET, MOTOR PULLEY, HD18	.58	2	3	9
00233	TRANSDUCER ASSY, TIMING, HD-18	257.20	2	5	15
00234	PCB, VR124-M20 (NEVADA), HD-18	1,990.50	2	5	15
08020	PCB, HD-18 CONTR.	461.00	2	3	9
28041	PANEL, FRONT, HD-18	52.71	2	2	3
28044	COVER, BOTTOM, HD-18	131.50	2	2	3
28045	PANEL, REAR, HD-18	49.11	2	2	3
28046	COVER, TOP, HD-18	70.41	2	2	3
31008	FAN, INTAKE, HD-18	47.26	2	2	5
31009	FILTER, AIR, HD-18	15.67	2	2	5
34004	FILTER, AC LINE, HD-18	40.34	2	2	5
49004	SEALED ASSY, HD-18, 110/60	3,052.61	2	2	5
49007	SEALED ASSY, HD-18, 220V 50HZ	3,052.61	2	2	5
74005	TRANSFORMER, HD-18	64.06	2	2	3
77054	CABLE, DISK CONTR, HD-18	43.94	2	2	3
77063	CABLE, 15 COND	38.03	2	2	3
82029	PULLEY, MOTOR, 60HZ, HD18	73.65	2	2	3
82030	PULLEY, MOTOR, 50HZ, HD18	43.33	2	2	3
82032	CLIP, CAP MTG, 220V, HD18	8.75	2	2	3
82035	DAMPENER, VIBRATION, HD18	2.63	2	2	5

MAJOR SPARE PARTS LIST (INCLUDES STOCKING LEVELS) FOR HDS-5  
 LAST FILE UPDATE - 4 - 1 - 1982

PART #	DESCRIPTION	SUGGESTED RETAIL PRICE	NUMBER OF SPARES REQUIRED TO SUPPORT		
			25	100	500
00152	PCB, HD-5 CONTR, HRZ	243.78	2	3	9
00157	PCB, HD5 CONTR, ADV	212.85	2	3	9
00399	WIRE, HD-5 GROUNDING, ADV	3.75	2	2	5
00495	POWER SUPPLY, HD-5, HRZ	66.00	2	3	9
00573	CABLE, HD-5 PWR SUPPLY	9.65	2	2	3
00577	CABLE, HD-5 CONTRL	41.90	2	2	3
00578	CABLE, HD-5 R/W	32.83	2	2	3
00580	DRIVE, HD-5 (GENERIC)	2,995.00	2	3	9
82048	DRIVE, HD-5, SEAGATE ST-506	2,995.00	2	3	9

Number 3  
Date APRIL 1, 1982  
Page 1 of 3

MODULE EXCHANGE AND  
FIXED-FEE REPAIR  
SCHEDULES REVISED

Effective April 15, 1982, North Star's Module Exchange Program and Fixed - Fee Repair Program will be based on the revised schedules attached.

Please make note of the new items covered under these programs as well as the new pricing.

APPROVED	DATE	SUPERSEDES	DATED	VERIFIED BY	DATE

NORTH STAR TECHNICAL BULLETIN #3

## EXCHANGE MODULES

NORTH STAR P/N	PART DESCRIPTION	EXCHANGE PRICE
00102	PCB, MAIN ASSY, ADVANTAGE	\$209.00
00113	PCB, SIO, ADVANTAGE	79.00
00148	PCB, PIO, ADVANTAGE	79.00
00152	PCB, HD-5 CONTROLLER, HORIZON	130.00
00157	PCB, HD-5 CONTROLLER, ADVANTAGE	130.00
08006	PCB, MB-4 (HORIZON MOTHERBOARD)	79.00
08008	PCB, FPB-A (FLOATING POINT BOARD)	144.00
08009	PCB, MDS-CTRL-D (MDS CONTROLLER)	130.00
08014	PCB, ZPB-A (Z80 PROCESSOR BOARD)	96.00
00134	PCB, HSIO-4 (MULTI USER SIO BOARD)	79.00
08012	PCB, RAM-16 (16K RAM BOARD)	79.00
08013	PCB, RAM-32 (32K RAM BOARD)	96.00
00128-03	PCB, HRAM-32 (32K HRAM BOARD)	96.00
00128-02	PCB, HRAM-48 (48K HRAM BOARD)	114.00
00128-01	PCB, HRAM-64 (64K HRAM BOARD)	130.00
08020	PCB, HD-18 (HARD DISK CONTROLLER)	96.00
00234	PCB, MARKSMAN (HD-18 NEVADA BOARD)	576.00
00357	KEYBOARD, ADVANTAGE	79.00
00495	POWER SUPPLY ASSY HD-5, HORIZON	48.00
00580	DRIVE, HD-5	480.00
49001	DRIVE, SHUGART SA-400	180.00
49002	DRIVE, TANDON TM100-2	202.00

IMPORTANT - All modules are shipped from North Star's Module Exchange Bank in the standard North Star configuration. Modules which have been modified in any way (including options) are not subject to exchange.

030182

NORTH STAR TECHNICAL BULLETIN #3FIXED FEE SCHEDULE

NORTH STAR P/N	PART DESCRIPTION	REPAIR PRICE
00102	PCB, MAIN ASSY, ADVANTAGE	\$174.00
00113	PCB, SID, ADVANTAGE	66.00
00148	PCB, PIO, ADVANTAGE	66.00
00152	PCB, HD-5 CONTROLLER, HORIZON	108.00
00157	PCB, HD-5 CONTROLLER, ADVANTAGE	108.00
00357	KEYBOARD, ADVANTAGE	66.00
00495	POWER SUPPLY, HD-5, HORIZON	40.00
08006	PCB, MB-4 (HORIZON MOTHERBOARD)	66.00
08008	PCB, FPB-A (FLOATING POINT BOARD)	120.00
08009	PCB, MDS-CTRL-D (MDS CONTROLLER)	108.00
08014	PCB, ZPB-A (Z80 PROCESSOR BOARD)	80.00
00134	PCB, HSIO-4 (MULTI USER SIO BOARD)	66.00
08012	PCB, RAM-16 (16K RAM BOARD)	66.00
08013	PCB, RAM-32 (32K RAM BOARD)	80.00
00128-03	PCB, HRAM-32 (32K HRAM BOARD)	80.00
00128-02	PCB, HRAM-48 (48K HRAM BOARD)	95.00
00128-01	PCB, HRAM-64 (64K HRAM BOARD)	108.00
08020	PCB, HD-18 (HARD DISK CONTROLLER BOARD)	108.00
00234	PCB, MARKSMAN (CENTURY DATA NEVADA BOARD)	480.00
00580	DRIVE, HD-5	400.00
49001	DRIVE, SHUGART SA-400	150.00
49002	DRIVE, TANDON TM100-2	168.00
49004	SEALED ASSY, HD-18	600.00
9440X	ADVANTAGE COMPUTER COMPLETE	see note
92XXX	HORIZON COMPUTER COMPLETE (DOUBLE DENSITY)	see note
94XXX	HORIZON COMPUTER COMPLETE (QUAD DENSITY)	see note
80001	HDS-18 HARD DISK SYSTEM COMPLETE	see note

FIXED FEES AND CURRENT HOURLY LABOR RATES QUOTED ARE SUBJECT TO CHANGE WITHOUT PRIOR NOTICE.

ONLY ASSEMBLIES LISTED ABOVE WILL BE ACCEPTED FOR REPAIR.

FIXED FEE CHARGES FOR COMPLETE UNITS (HORIZON AND ADVANTAGE COMPUTERS AND HARD DISK SYSTEMS) WILL BE BASED ON THE FIXED FEE CHARGE FOR THE ASSEMBLY(IES) FOUND TO BE DEFECTIVE. AN ADDITIONAL \$75.00 WILL BE CHARGED TO COVER THE COSTS OF COMPLETE SYSTEM TESTING.

Number **4**  
Date **JUNE 28, 1982**  
Page **1** of **1**

**MOVE NOTICE**

North Star's Technical Services Department has moved to its new facility located just up the street from the main North Star building at 14310 Catalina Street, San Leandro, CA 94577. The new building will provide the technical support and product repair groups with larger and more efficient quarters enabling them to serve you better. Additionally, North Star's new training facility will be located in the new building.

Technical Telephone Support is still available at the same numbers, (415) 357-6990 or (415) 357-4356. However, it is no longer possible for the main switchboard to transfer a call from North Star's main telephone number to the Support Line. North Star customers must use the above numbers for telephone support.

All items being returned to North Star Product Service for repair must be shipped to the new address in the future. Please make note of this change in your Dealer Manual.

We at North Star are very pleased about our new Technical Center and are confident the new facility will enable us to provide you with improved services. Again, our new shipping address for repairs is:

**PRODUCT SERVICE**  
**NORTH STAR COMPUTERS, INC.**  
**14310 CATALINA STREET**  
**SAN LEANDRO, CA 94577**



Number 5  
Date JUNE 21, 1982  
Page 1 of 4

## IMPORTANT INFORMATION

A systematic failure mode has been discovered in a defined number of ADVANTAGE Video PCBs (North Star Part Number 00365). This failure mode can cause damage to those ADVANTAGE 20 and HD-5 units affected. This failure mode was discovered early enough at North Star to prevent a large number of units from being shipped. However, our records indicate that approximately 200 ADVANTAGE 20 and 10/HD-5 units may have been shipped containing this problem.

### THE PROBLEM:

The primary failure mode is a failure of capacitor C438 on the Elston supplied video PCB. See attached assembly drawing (Figure 1) for parts location. NOTE: ONLY PCBs CONTAINING A YELLOW .022 Mf RECTANGULAR CAPACITOR MADE BY PHILIPS ARE PRONE TO THIS FAILURE. Boards containing an axial lead tubular .022 Mf capacitor are okay.

Once capacitor C438 fails, excessive current will flow through resistor R478 and diode CR408 causing failure of those components, discoloring and possible burning of the PCB material.

The primary method of determining if any ADVANTAGE in your inventory requires attention is by comparing the serial number of the ADVANTAGE with the list of serial numbers attached to this bulletin. This list contains the serial numbers of all ADVANTAGE computers known to have shipped from North Star which could contain the problem capacitor. We suspect that approximately 80% of the units listed contain the bad capacitor.

In any event, the failure follows a predictable degradation path and can be detected as follows:

A monitor that has the problem in an advanced stage will exhibit a folding over of the characters in the first three inches (from the left side) of the screen. Three or four vertical lines on the left half of the screen or possibly a complete lack of video on the left side may also be apparent.

Failures can be detected early (prior to doing any permanent damage) by turning up the brightness to maximum on suspect ADVANTAGES. One should be able to detect a faint vertical line three to four inches from the left of the screen on affected machines. Since the failure, once started, degrades with time, the line will become brighter and characters on the left side of the screen will become distorted at late stages.

CORRECTING THE PROBLEM:

North Star will supply replacement capacitors, replacement PCBs or repair any affected ADVANTAGES free of charge.

CORRECTIVE ACTION OPTION ONE

You may receive replacement capacitors free of charge by calling Barry Bearden at North Star. Additionally, North Star will issue a \$20.00 credit per ADVANTAGE to any Authorized Dealer, Distributor or OEM performing this modification. To receive this credit please indicate the serial number(s) of unit(s) being modified when you call. A credit memo will be issued upon verification of the serial number. Replacement of this capacitor by competent service personnel will not void the North Star warranty. NOTE: REPLACEMENT OF THE CAPACITOR SHOULD NOT EFFECT THE VIDEO ALIGNMENT OF THE ADVANTAGE.

CORRECTIVE ACTION OPTION TWO

Complete ADVANTAGES containing serial numbers listed on the attached may be returned to North Star Product Service for replacement of the defective capacitor.

CORRECTIVE ACTION OPTION THREE

Replacement Video PCBs will be supplied free of charge upon receipt of returned boards. If you choose this option please return the PCB as a warranty repair. North Star's Product Service Department will send a replacement board immediately upon receipt of the returned board. NOTE: REPLACEMENT OF THE VIDEO PCB WITHOUT ALSO REPLACING THE CRT REQUIRES REALIGNMENT OF THE VIDEO CIRCUITRY ON THE PCB. FOR THIS REASON OPTION THREE IS NOT RECOMMENDED.

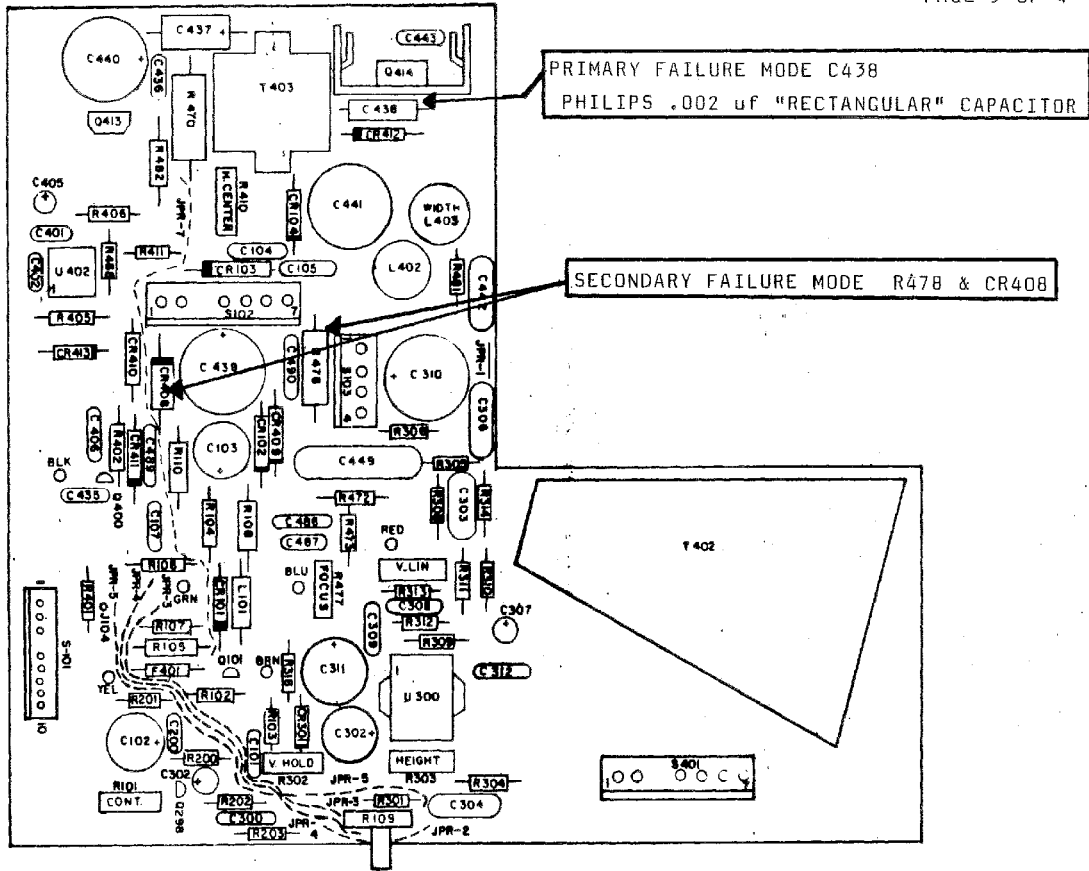

DM30-12B0-119-C31				
NORTH STAR				
DRAWN	DATE	APPVD	DATE	
D. DAUNCE	10/14/81	RGB	10-14-81	
ELSTON ELECTRONICS			RP	RGB

REV DATE

5383	6367	6494	6721
5781	6368	6495	6724
5831	6370	6502	6725
5916	6373	6510	6742
6133	6374	6516	6743
6159	6375	6520	6745
6160	6376	6524	6750
6164	6377	6525	6753
6166	6378	6526	6754
6207	6379	6528	6757
6208	6382	6541	6758
6213	6396	6543	6760
6218	6397	6544	6762
6226	6398	6549	6763
6266	6400	6552	6764
6284	6403	6573	6765
6286	6404	6575	6766
6293	6405	6576	6783
6303	6409	6578	6788
6305	6411	6583	6791
6306	6415	6585	6792
6307	6418	6590	6907
6309	6419	6592	
6310	6422	6601	
6311	6426	6602	
6314	6429	6605	
6317	6430	6611	
6318	6436	6614	
6323	6439	6624	
6325	6440	6631	
6326	6444	6633	
6328	6445	6634	
6329	6447	6636	
6332	6450	6645	
6335	6451	6647	
6337	6453	6648	
6338	6454	6651	
6339	6455	6656	
6340	6456	6657	
6341	6458	6659	
6342	6459	6660	
6344	6461	6665	
6345	6465	6668	
6346	6468	6674	
6347	6472	6695	
6350	6473	6696	
6351	6474	6698	
6353	6476	6699	
6354	6478	6702	
6355	6479	6703	
6359	6480	6704	
6361	6482	6708	
6363	6483	6711	
6364	6486	6713	
6366	6490	6714	
	6491	6719	

Number 9  
 Date Sept 29, 1982  
 Page 1 of 1

NORTH STAR ADVANTAGE CP/M® REVISION A BUG FIX

A bug has been identified in NORTH STAR ADVANTAGE CP/M REVISION A. This bug manifests itself as a "BDOS ERR on A: R/O" when none should occur. To eliminate this bug make the following modification to the diskette by running the CP/M "copy" program to copy the factory master. DO NOT modify the factory master.

- Install a working diskette (REV A) in your ADVANTAGE
- Type "DDT CPMGEN.COM"
- Type "L2F55" this will display the old code of  
 ANI 02  
 JNZ F3A6
- Type "A2F55" this allows you to enter the patch
- Type "MVI A, 99"
- Type "STA FD68"
- Type CNTL "C" to warm boot
- Type "SAVE 57 NEWGEN.COM"
- Remove factory master and insert working diskette just created in drive A
- Try to recreate the problem
- If the fix was successful, then rename NEWGEN.COM to CPMGEN.COM
- Use CPMGEN.COM to place the new system onto all of your working diskettes

\*\*\*\*DO NOT MODIFY THE FACTORY MASTER\*\*\*\*

NOTE: This bug is fixed in CP/M release 1.1.0

APPROVED	DATE	SUPERSEDES	DATED	VERIFIED BY	DATE
				<i>[Signature]</i>	10/1/82

Number 8  
 Date Sept 29, 1982  
 Page 1 of 1

NORTH STAR HORIZON® CP/M® REVISION 1.1.0 BUG FIX

A bug has been identified in NORTH STAR HORIZON REVISION 1.1.0. This bug manifests itself as a "BDOS ERR on A: R/O" when none should occur. To eliminate this bug make the following modification to the CPMGEN.COM file on a working diskette. Create a working diskette by running the CP/M "copy" program to copy the factory master. DO NOT modify the factory master.

- Install a working diskette (REV 1.1.0) in your HORIZON
- Type "DDT CPMGEN.COM"
- Type "A2f31" this will display the old code of  
 ANI 02  
 JNZ 7992
- Type "A2F31" this will allow you to enter the patch
- Type "MVI A, 99"
- Type "STA 7FAB" this will prevent buffering error
- Type CNTL "C" to warm boot
- Type "SAVE 51 NEW CPM.COM"
- Remove factory master and insert working diskette just created in drive A
- Try to recreate the problem
- If the fix was successful, then rename NEWGEN.COM to CPMGEN.COM
- Use CPMGEM.COM to place the new system onto all of your working diskettes

\*\*\*\*DO NOT MODIFY THE FACTORY MASTER\*\*\*\*

NOTE: This bug is fixed in CP/M release 1.1.1

APPROVED	DATE	SUPERSEDES	DATED	VERIFIED BY	DATE
				<i>[Signature]</i>	<i>[Signature]</i>



TO: ALL NORTH STAR DEALERS, DISTRIBUTORS AND OEMS  
FROM: AL PETERSON - MANAGER, TECHNICAL SERVICES  
SUBJECT: COMPLIANCE WITH FCC REGULATIONS

The attached Field Change Notices and associated labels are required for North Star HORIZON(R) and North Star ADVANTAGE computer systems and HD-18 hard disk and Tape Backup systems to bring us into compliance with Federal Communications Commission regulations. The FCNs apply to product sold only within the United States. Compliance is not required for non-US sold product.

Please follow the FCN directions carefully and apply the enclosed labels to all North Star products currently in your inventory. Offering North Star equipment for sale without these labels applied may result in a citation from the FCC. Therefore, it's very important that the labels be applied immediately.

These labels serve to notify the user that our equipment has not been tested for conformance to FCC Class A regulations. We have until April, 1983 to complete testing and bring our products into conformance. We will complete testing well in advance of that time. Then the label will be changed to read that the equipment has been tested and is in full compliance with FCC Class A rules. In the interim the attached labels will be used and permit you to sell North Star equipment without concern for being in violation of any FCC regulations. All future shipments from North Star will have the FCC stickers applied to our equipment.

If additional labels are needed beyond the 5 sets supplied, please contact our Product Service Department at 415-357-8500, ext.7525. Thank you.

Number 2
Date JULY 13, 1982
Page 1 of 3

Models Affected: ADVANTAGE COMPUTER Class of Change: MANDATORY
Assembly(s) Affected: ADVANTAGE USER Field Action: INSTALL ON ALL UNITS
MANUAL FINAL ASSEMBLY IN INVENTORY
Factory Implementation: 7-1-82 Est. Install. Time: 0.1 Hrs.

1. REASON FOR CHANGE

FCC stickers (see Figure 1) must be affixed to all unsold ADVANTAGE computer systems and ADVANTAGE USER MANUALS in order to comply with Federal Communications Commission regulations.

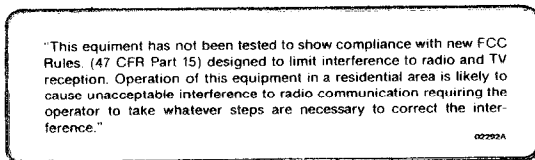

SYSTEM STICKER

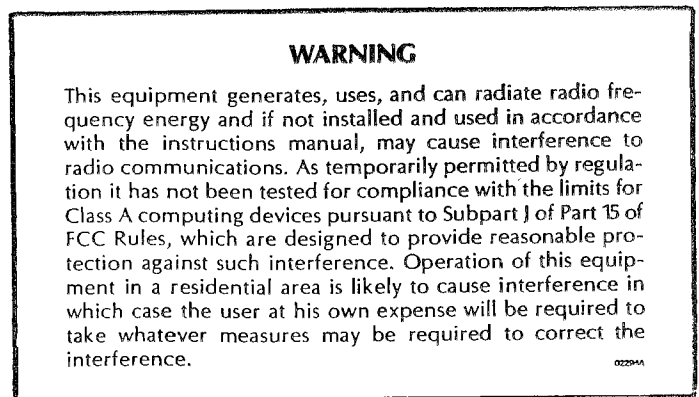

MANUAL STICKER

FIGURE 1

2. DESCRIPTION OF CHANGE

Application of a self adhesive FCC sticker (North Star Part Number 02292A) to rear of all ADVANTAGE computers currently in inventory. Application of a self adhesive FCC sticker (North Star Part Number 02294A) to the inside surface of the rear cover of all ADVANTAGE USER MANUALS currently in inventory.

1-Reason for change 2-Description of change 3-Revision ID 4-Rework instructions 5-Checkout procedure 6-Tools required 7-Parts required 8-Effect on spares 9-Documentation affected 10-Software affected 11-Attachments

Table with 6 columns: APPROVED, DATE, SUPERSEDES, DATED, VERIFIED BY, DATE. Includes handwritten signatures and dates.



3. REVISION IDENTIFICATION

N/A

4. REWORK INSTRUCTIONS

ADVANTAGE COMPUTER

Apply self adhesive FCC sticker (North Star Part Number 02292A) to the rear of all ADVANTAGE computer systems currently in inventory as indicated in Figure 2.

ADVANTAGE USER MANUAL

Apply self adhesive FCC sticker (North Star Part Number 02294A) to the inside surface of the rear cover of the manual.

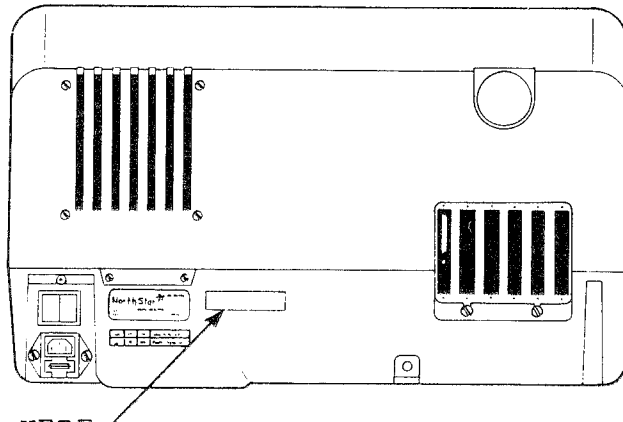

AFFIX LABEL HERE

FIGURE 2

5. CHECKOUT PROCEDURE

N/A

6. TOOLS REQUIRED

NONE

7. PARTS REQUIRED

NORTH STAR PART NUMBER	PART DESCRIPTION	LIST PRICE
02292A	LABEL, SYSTEM, FCC	N/C
02294A	LABEL, MANUAL, FCC	N/C

8. EFFECT ON SPARES

NONE

9. DOCUMENTATION AFFECTED

ADVANTAGE USER MANUAL (North Star Part Number 26024).

10. SOFTWARE AFFECTED

NONE

11. ATTACHMENTS

Strip of five (5) SYSTEM FCC stickers (North Star Part Number 02292A).

Strip of five (5) MANUAL FCC stickers (North Star Part Number 02294A).

NOTE: FOR ADDITIONAL STICKERS PLEASE CONTACT BARRY BEARDEN AT  
(415) 357-8500 EXT. 7525.

Number 3  
Date JULY 13, 1982  
Page 1 of 3

Models Affected: HORIZON(R) COMPUTER Class of Change: MANDATORY  
HORIZON SYSTEM MANUAL  
Assembly(s) Affected: FINAL ASSEMBLY Field Action: INSTALL ON ALL UNITS  
IN INVENTORY  
Factory Implementation: 7-1-82 Est. Install. Time: 0.1 Hrs.

## 1. REASON FOR CHANGE

FCC stickers (see Figure 1) must be affixed to all unsold HORIZON computer systems and HORIZON SYSTEM MANUALS in order to comply with Federal Communications Commission regulations.

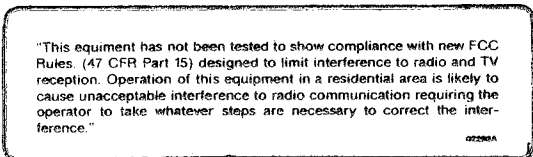

SYSTEM STICKER

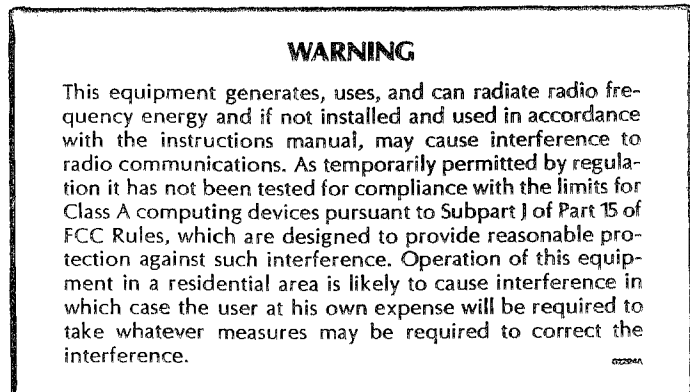

MANUAL STICKER

FIGURE 1

## 2. DESCRIPTION OF CHANGE

Application of a self adhesive FCC sticker (North Star Part Number 02292A) to rear of all HORIZON computers currently in inventory.  
Application of a self adhesive FCC sticker (North Star Part Number 02294A) to the inside surface of the rear cover of all HORIZON SYSTEM MANUALS currently in inventory.

1—Reason for change 2—Description of change 3—Revision ID 4—Rework instructions 5—Checkout procedure 6—Tools required 7—Parts required 8—Effect on spares 9—Documentation affected 10—Software affected 11—Attachments

APPROVED	DATE	SUPERSEDES	DATED	VERIFIED BY	DATE
	7-14-82	N/A			7-14

3. REVISION IDENTIFICATION

N/A

4. REWORK INSTRUCTIONS

HORIZON COMPUTER

Apply self adhesive FCC sticker (North Star Part Number 02292A) to the rear of all HORIZON computer systems currently in inventory as indicated in Figure 2.

HORIZON SYSTEM MANUAL

Apply self adhesive FCC sticker (North Star Part Number 02294A) to the inside surface of the rear cover of the manual.

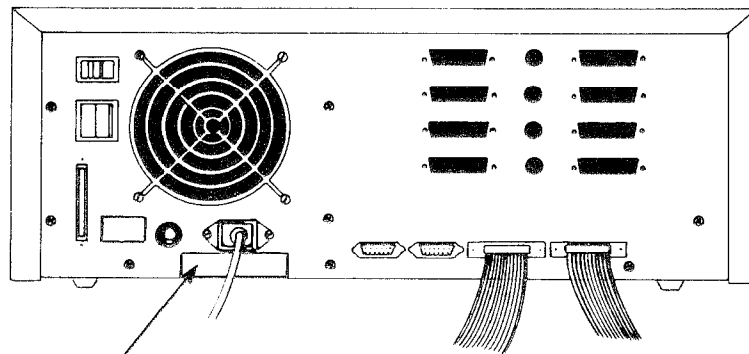

AFFIX LABEL HERE

FIGURE 2

5. CHECKOUT PROCEDURE

N/A

6. TOOLS REQUIRED

NONE

Field Change Notice # 3  
July 13, 1982  
Page 3 of 3

7. PARTS REQUIRED

NORTH STAR PART NUMBER	PART DESCRIPTION	LIST PRICE
02292A	LABEL, SYSTEM, FCC	N/C
02294A	LABEL, MANUAL, FCC	N/C

8. EFFECT ON SPARES

NONE

9. DOCUMENTATION AFFECTED

HORIZON COMPUTER SYSTEM MANUAL (North Star Part Number 25011).

10. SOFTWARE AFFECTED

NONE

11. ATTACHMENTS

NOTE: NO STICKERS ARE SUPPLIED WITH THIS FCN. A STRIP OF FIVE (5) STICKERS ARE ATTACHED TO FCN #2. FOR ADDITIONAL STICKERS PLEASE CONTACT BARRY BEARDEN AT (415) 357-8500 EXT. 7525.

Number 4  
 Date JULY 13, 1982  
 Page 1 3

Models Affected: HD-18 HARD DISK SYSTEM Class of Change: MANDATORY  
 HD-18 USER/TECH MANUAL  
 Assembly(s) Affected: FINAL ASSEMBLY Field Action: INSTALL ON ALL UNITS  
 IN INVENTORY  
 Factory Implementation: 7-1-82 Est. Install. Time: 0.1 Hrs.

1. REASON FOR CHANGE

FCC stickers (see Figure 1) must be affixed to all unsold HD-18 hard disk systems and HD-18 USER/TECH MANUALS in order to comply with Federal Communications Commission regulations.

"This equipment has not been tested to show compliance with new FCC Rules. (47 CFR Part 15) designed to limit interference to radio and TV reception. Operation of this equipment in a residential area is likely to cause unacceptable interference to radio communication requiring the operator to take whatever steps are necessary to correct the interference."  
 02292A

SYSTEM STICKER

**WARNING**  
 This equipment generates, uses, and can radiate radio frequency energy and if not installed and used in accordance with the instructions manual, may cause interference to radio communications. As temporarily permitted by regulation it has not been tested for compliance with the limits for Class A computing devices pursuant to Subpart J of Part 15 of FCC Rules, which are designed to provide reasonable protection against such interference. Operation of this equipment in a residential area is likely to cause interference in which case the user at his own expense will be required to take whatever measures may be required to correct the interference.  
 02294A



MANUAL STICKER

FIGURE 1

2. DESCRIPTION OF CHANGE

Application of a self adhesive FCC sticker (North Star Part Number 02292A) to rear of all HD-18 hard disk systems currently in inventory. Application of a self adhesive FCC sticker (North Star Part Number 02294A) to the inside surface of the rear cover of all HD-18 USER/TECH MANUALS currently in inventory.

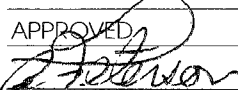
1—Reason for change 2—Description of change 3—Revision ID 4—Rework instructions 5—Checkout procedure 6—Tools required 7—Parts required 8—Effect on spares 9—Documentation affected 10—Software affected 11—Attachments

APPROVED	DATE	SUPERSEDES	DATED	VERIFIED BY	DATE
	7-14-82	N/A			7-14

3. REVISION IDENTIFICATION

N/A

4. REWORK INSTRUCTIONS

HD-18 HARD DISK SYSTEM

Apply self adhesive FCC sticker (North Star Part Number 02292A) to the rear of all HD-18 hard disk systems currently in inventory as indicated in Figure 2.

HD-18 USER/TECH MANUAL

Apply self adhesive FCC sticker (North Star Part Number 02294A) to the inside surface of the rear cover of the manual.

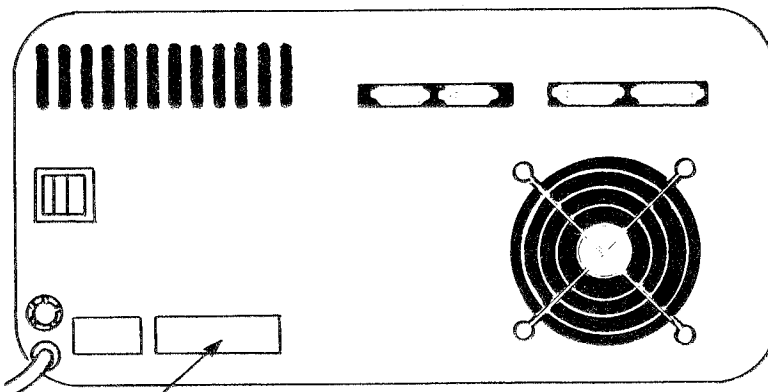

AFFIX LABEL HERE

FIGURE 2

5. CHECKOUT PROCEDURE

N/A

6. TOOLS REQUIRED

NONE

Field Change Notice # 4  
July 13, 1982  
Page 3 of 3

7. PARTS REQUIRED

NORTH STAR PART NUMBER	PART DESCRIPTION	LIST PRICE
02292A	LABEL, SYSTEM, FCC	N/C
02294A	LABEL, MANUAL, FCC	N/C

8. EFFECT ON SPARES

NONE

9. DOCUMENTATION AFFECTED

HD-18 USER/TECH MANUAL (North Star Part Number 25031).

10. SOFTWARE AFFECTED

NONE

11. ATTACHMENTS

NONE

NOTE: NO STICKERS ARE SUPPLIED WITH THIS FCN. A STRIP OF FIVE (5) STICKERS ARE ATTACHED TO FCN #2. FOR ADDITIONAL STICKERS PLEASE CONTACT BARRY BEARDEN AT (415) 357-8500 EXT. 7525.



Number 5  
 Date JULY 13, 1982  
 Page 1 of 3

Models Affected: **TAPE BACK-UP SYSTEM** Class of Change: **MANDATORY**  
 Assembly(s) Affected: **FINAL ASSEMBLY** Field Action: **INSTALL ON ALL UNITS IN INVENTORY**  
 Factory Implementation: **7-1-82** Est. Install. Time: **0.1** Hrs.

1. REASON FOR CHANGE

FCC stickers (see Figure 1) must be affixed to all unsold TAPE BACK-UP SYSTEMS in order to comply with Federal Communications Commission regulations.

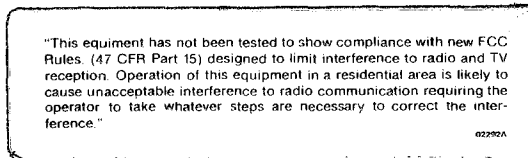

SYSTEM STICKER

FIGURE 1

2. DESCRIPTION OF CHANGE

Application of a self adhesive FCC sticker (North Star Part Number 02292A) to rear of all TAPE BACK-UP SYSTEMS currently in inventory.

1—Reason for change 2—Description of change 3—Revision ID 4—Rework instructions 5—Checkout procedure 6—Tools required 7—Parts required 8—Effect on spares 9—Documentation affected 10—Software affected 11—Attachments

APPROVED	DATE	SUPERSEDES	DATED	VERIFIED BY	DATE
<i>[Signature]</i>	7-14-82	N/A		<i>[Signature]</i>	7-14

3. REVISION IDENTIFICATION

N/A

4. REWORK INSTRUCTIONS

Apply self adhesive FCC sticker (North Star Part Number 02292A) to the rear of all TAPE BACK-UP SYSTEMS currently in inventory as indicated in Figure 2.

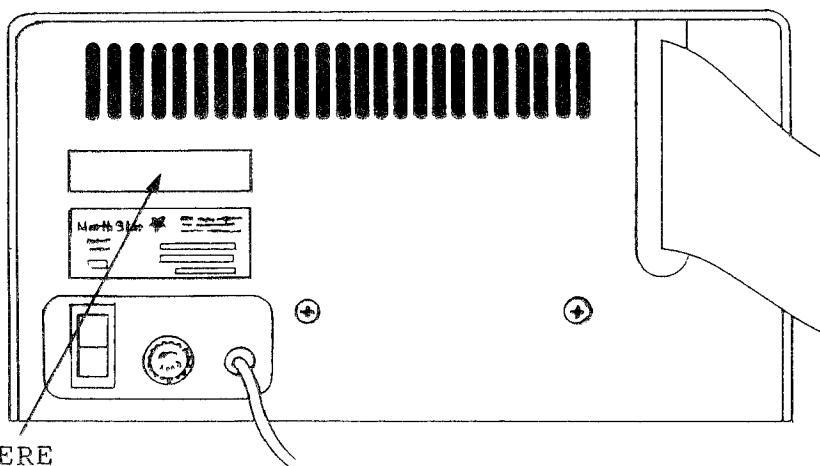

AFFIX LABEL HERE

FIGURE 2

5. CHECKOUT PROCEDURE

N/A

6. TOOLS REQUIRED

NONE

Field Change Notice # 5  
July 13, 1982  
Page 3 of 3

7. PARTS REQUIRED

NORTH STAR PART NUMBER	PART DESCRIPTION	LIST PRICE
02292A	LABEL, SYSTEM, FCC	N/C

8. EFFECT ON SPARES

NONE

9. DOCUMENTATION AFFECTED

NONE

10. SOFTWARE AFFECTED

NONE

11. ATTACHMENTS

NONE

NOTE: NO STICKERS ARE SUPPLIED WITH THIS FCN. A STRIP OF FIVE (5) STICKERS ARE ATTACHED TO FCN #2. FOR ADDITIONAL STICKERS PLEASE CONTACT BARRY BEARDEN AT (415) 357-8500 EXT. 7525.

Number 6  
 Date November 15, 1982  
 Page 1 of 1

DUAL VOLTAGE CONTROLLED OSCILLATOR

To ensure that all circuits utilizing a 74S124 dual voltage controlled oscillator will function under all conditions, North Star has begun to select all 74S124s for maximum frequency performance.

It is strongly suggested that when replacing any 74S124 dual VCO only North Star Part Number 43147 be used. 74S124 dual VCOs are used in North Star products as outlined below.

IC COORDINATE

LOCATION

1-A	PCB, MAIN ASSEMBLY, ADV (P/N 00102)
12-C	PCB, HD-5 CONTROL, HRZ (P/N 00152)
5-C	PCB, HD-5 CONTROL, ADV (P/N 00157)

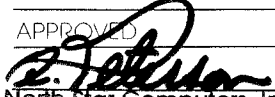
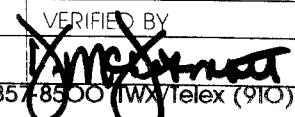
APPROVED	DATE	SUPERSEDES	DATED	VERIFIED BY	DATE
	11-10-82				11-11-82

North Star Computers, Inc. 14440 Catalina St., San Leandro, CA 94577 USA (415) 357-8500 (TWX) Telex (910) 366-7001

Number 7  
 Date November 20, 1982  
 Page 1 of 1

## NORTH STAR HD-5 BAD SPOTS

A bad spot is a common term used to describe media defects in rotating magnetic memory storage devices or hard disks. It is typical during the life cycle of a hard disk drive that bad spots will occasionally occur. They are caused by shock, vibration, loss of power and any other event which can cause the head assembly to unexpectedly impact the media surface.

North Star provides for the detection of bad spots in the hard disk testing and formatting programs. When a bad spot is detected the location of the bad spot is mapped out during reformat and the user can then continue to use the hard disk with confidence.

North Star's field specification for the maximum allowable number of bad spots on an HD-5 Hard Disk System as 16.

North Star will not accept HD-5's returned from the field due to excessive bad spots if the number of bad spots is equal to or less than 16.

NOTE: Sixteen bad spots result in a loss of less than 3% of the total storage capacity of the hard disk.

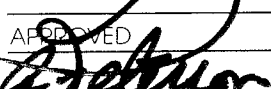
APPROVED	DATE	SUPERSEDES	DATED	VERIFIED BY	DATE
	11-10-82				11-11-82

Number 10  
 Date December 1, 1982  
 Page 1 of 3

CURRENT ON-SITE AND CARRY-IN SERVICE LOCATIONS

As of November 12, 1982 MAI/Sorbus Service Division offers ON-SITE Service for North Star products in 50 locations and CARRY-IN Service in 13 locations.

A list of ON-SITE Service areas (with local telephone number) can be found on page two of this Technical Bulletin.

A list on CARRY-IN Service locations (also with local telephone number) can be found on page three.

NOTE: You may also contact Sorbus Account Management at (800) 345-1262. PA residents please call (215) 296-6000 for details on both ON-SITE and CARRY-IN programs.

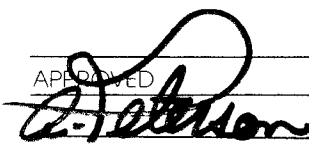
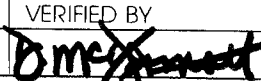
APPROVED	DATE	SUPERSEDES	DATED	VERIFIED BY	DATE
	11-30-82				11-30-82

SORBUS ON-SITE LOCATION

AL, BIRMINGHAM  
(205) 942-8872

KY, LOUISVILLE  
(502) 589-0595

OH, CLEVELAND  
(216) 362-7230

AZ, PHOENIX  
(602) 246-1085

LA, NEW ORLEANS  
(504) 456-6010

OH, COLUMBUS  
(614) 864-7280

CA, LOS ANGELES  
(213) 843-4441

MA, BOSTON  
(617) 237-4550

OH, DAYTON  
(513) 821-6309

CA, SAN BERNARDINO  
(714) 991-0240

MD, BALTIMORE  
(301) 242-2336

OH, TOLEDO  
(419) 472-1918

CA, ORANGE  
(714) 991-0240

MI, DETROIT  
(313) 425-7530

OK, OKLAHOMA CITY  
(405) 528-8867

CA, SACRAMENTO  
(916) 920-3182

MN, MINNEAPOLIS  
(612) 870-8974

OR, PORTLAND  
(503) 222-3891

CA, SAN DIEGO  
(714) 565-7905

MO, KANSAS CITY  
(913) 831-1700

PA, PHILADELPHIA  
(215) 337-9800

CA, SAN FRANCISCO  
(415) 483-9962

MO, ST. LOUIS  
(314) 739-7509

PA, PITTSBURG  
(412) 271-7131

CA, SAN JOSE  
(408) 984-1947

NC, GREENSBORO  
(704) 535-6970

TN, MEMPHIS  
(901) 345-2853

CO, DENVER  
(303) 758-7511

NJ, CLIFTON  
(201) 779-5100

TN, NASHVILLE  
(901) 345-2853

CT, BRIDGEPORT  
(800) 431-1422

NY, BUFFALO  
(716) 631-9230

TX, DALLAS  
(214) 263-1987

CT, HARTFORD  
(203) 569-0880

NY, LONG ISLAND  
(516) 681-8176

TX, HOUSTON  
(713) 680-1420

FL, MIAMI  
(303) 940-0752

NY, NEW YORK  
(212) 867-4130

TX, SAN ANTONIO  
(512) 824-0412

FL, TAMPA  
(813) 877-5937

NY, ROCHESTER  
(716) 235-6820

UT, SALT LAKE CITY  
(801) 487-8679

GA, ATLANTA  
(404) 394-8994

OH, CINCINNATI  
(513) 489-7755

WASH, D.C.  
(703) 385-3207

IL, CHICAGO  
(312) 595-9280

WA, SEATTLE  
(206) 575-1202

IN, INDIANAPOLIS  
(317) 259-1191

WI, MILWAUKEE  
(414) 546-3700

KS, WICHITA  
(316) 262-2983

SORBUS CARRY-IN LOCATION

		<u>SYSTEM ONLY</u>	<u>ASSEMBLY ONLY</u>
CA, ANAHEIM	(714) 991-9500		X
CA, BURBANK	(213) 843-4441	X	
CA, SAN LEANDRO	(415) 483-9862	X	
CO, AURORA	(303) 360-0932	X	
GA, DORAVILLE	(404) 458-0620	X	
IL, BENSONVILLE	(312) 279-0070		X
MI, LIVONIA	(313) 425-7530	X	
MO, MARYLAND HEIGHTS	(314) 432-0425	X	
NY, HICKSVILLE	(516) 822-4242	X	
NY, ROCHESTER	(716) 235-6820	X	
PA, KING OF PRUSSIA	(215) 337-3822		X
TX, DALLAS	(214) 631-1734	X	
VA, FAIRFAX	(703) 385-3201	X	

NOTE: FOR LOCATIONS DESIGNATED AS SYSTEM LEVEL ONLY SERVICE, USERS MUST RETURN THE ENTIRE SYSTEM FOR SERVICE. LOCATIONS PERFORMING ASSEMBLY LEVEL SERVICE WILL ACCEPT MAJOR SUBASSEMBLIES (PCBs, DRIVES, ETC.) AS WELL AS COMPLETE SYSTEMS FOR REPAIR.



Number 11  
 Date November 22, 1982  
 Page 1 of 2

## 5 1/4" WINCHESTER HARD DISK DRIVE

North Star has determined that the 5 1/4" Winchester Hard Disk Drive must be shipped in an approved North Star Shipping Container. If improperly packaged, the unit may become damaged due to shock and vibration during shipment.

North Star will not accept any liability for damage to any 5 1/4" Winchester Hard Disk Drive not shipped in an approved North Star Shipping Container.

If you do not presently have an approved shipping container please request one from your Sales Administrator before returning any 5 1/4" Hard Disk to the factory. Make this request when calling for your Return Material Authorization (RMA) number. Containers must have the North Star shipping label (page 2) to indicate an approved container for the return of the 5 1/4" Winchester Hard Disk Drive.

NOTE: You void any and all warranties if any 5 1/4" Winchester Hard Disk Drive is shipped in any container other than the approved North Star Shipping Container.

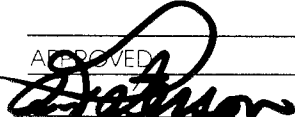
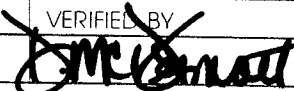
APPROVED	DATE	SUPERSEDES	DATED	VERIFIED BY	DATE
	11-22-82				12-1-82

**FRAGILE**



**REUSABLE CONTAINER**

**-SAVE- -SAVE- -SAVE-**

**5 1/4" HARD DISK  
MINI WINCHESTER DRIVE**

**Approved North Star Shipping Container**

- **SAVE** this "Approved North Star Shipping Container" for all 5 1/4" hard disk mini Winchester product returns to factory, your distributor or dealer.
- **WARNING:** North Star will not accept any liability for damage to any 5 1/4" Winchester hard disk drive not shipped in this "Approved North Star Shipping Container".
- **NOTE:** You void any and all warranties, expressed or implied, if any attempt is made to ship 5 1/4" Winchester hard disk product in any container other than this "Approved North Star Shipping Container".

**REUSABLE CONTAINER**

**-SAVE- -SAVE- -SAVE-**

**FRAGILE**

Number 12  
 Date November 22, 1982  
 Page 1 of 1

## USING THE ADVANTAGE PIO FOR GRAPHICS PRINTING

In order to use the ADVANTAGE PIO Board (North Star P/N 00148) with the NS100 printer, GDOS Revision 2.0 or higher, or GCP/M Revision 1.1.0 or higher must be used. Previous releases of GDOS and GCP/M did not support the use of ADVANTAGE PIO with the NS100 parallel interface.

Although it is possible to use other parallel printers with the ADVANTAGE PIO for graphics use, North Star currently supports the NS100 parallel printer only.

The pin-out connections for the North Star ADVANTAGE PIO Board are detailed in Figure 1.

### ADVANTAGE PIO INTERFACE CONNECTIONS

INPUT PORT		
PIN NUMBER		MEANING
1		DATA BIT 7
9		DATA BIT 6
2		DATA BIT 5
10		DATA BIT 4
11		DATA BIT 3
4		DATA BIT 2
12		DATA BIT 1
5		DATA BIT 0
15		SIGNAL GROUND
14		SIGNAL GROUND
13		SIGNAL GROUND
3		SIGNAL GROUND
7		P/I FLAG
8		INPUT SPARE
6		INPUT STROBE

OUTPUT PORT		
PIN NUMBER		MEANING
1		DATA BIT 7
9		DATA BIT 6
2		DATA BIT 5
10		DATA BIT 4
11		DATA BIT 3
4		DATA BIT 2
12		DATA BIT 1
5		DATA BIT 0
15		SIGNAL GROUND
14		SIGNAL GROUND
13		SIGNAL GROUND
3		SIGNAL GROUND
7		OUTPUT ACKNOWLEDGE
8		OUTPUT STROBE
6		P/O FLAG

FIGURE 1

APPROVED	DATE	SUPERSEDES	DATED	VERIFIED BY	DATE
<i>[Signature]</i>	11-20-82			<i>[Signature]</i>	12-1-82

November 18, 1982

Dear North Star Dealer:

TSS/C 1.0.1 is now available for shipment. This upgraded version features:

- SHUTDOWN procedure as documented.
- Revision of spooler handling overflow to fix problem.
- 2kbyte expansion of TPA allowing the application program to overwrite the CCP. The CCP is now reloaded when the application program exits CP/M.
- Support to Revision E HRAM-64 boards allowing TSS/C job to be configured with 56kbytes of memory. This is an increase of 4kbytes of TPA over version 1.0.0.

TSS/C 1.0.1 and a TSS/C 1.0.1 Upgrade are available. TSS/C 1.0.1 will have the same part number and price as TSS/C 1.0.0. TSS/C 1.0.1 Upgrade (part number 02519) will be dealer priced at \$38, with a suggested list of \$59.

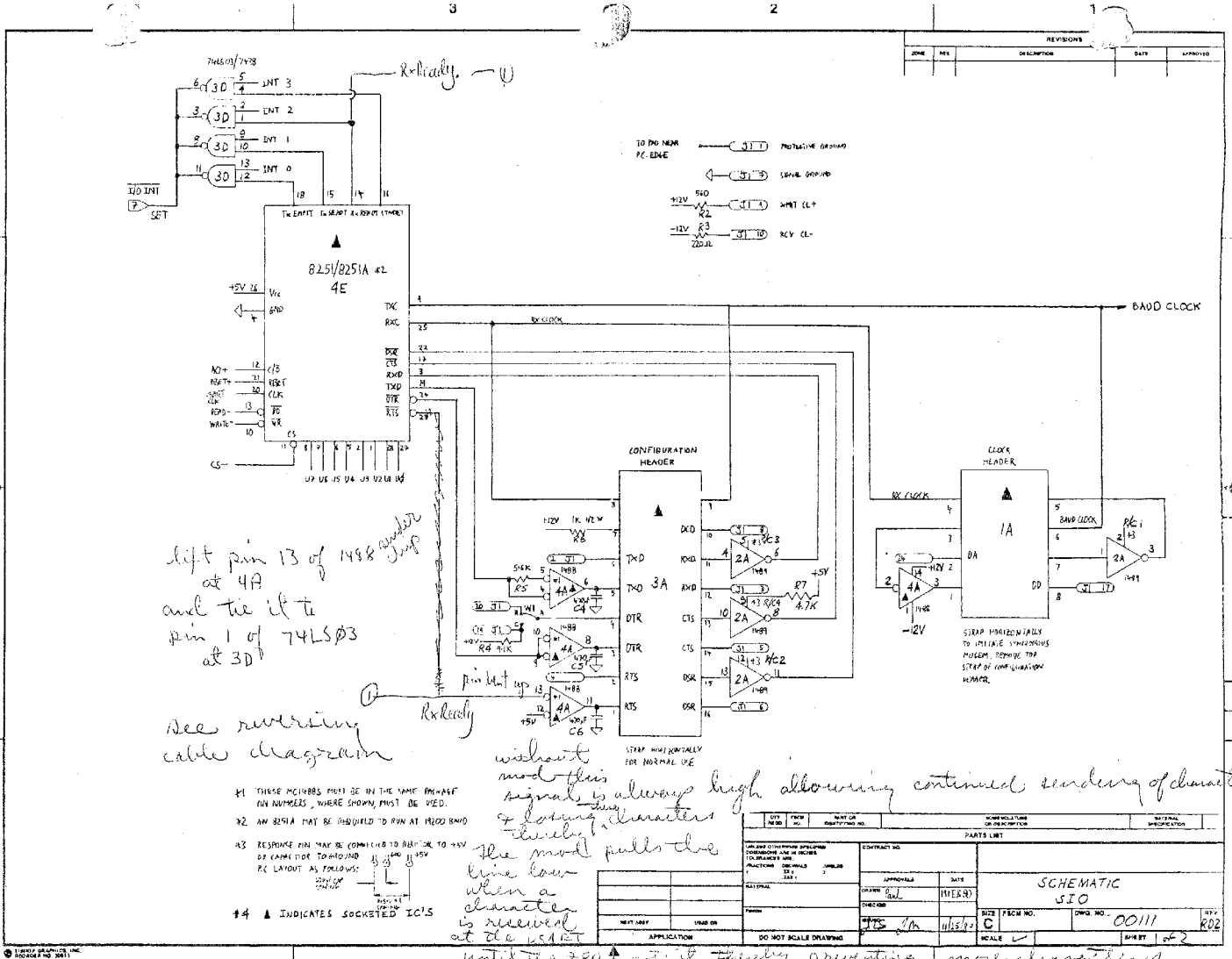

lift pin 13 of 1498 and tie it to pin 1 of 74LS03 at 3D

See reversing cable diagram

Ready

without this signal is always high allowing continued sending of characters  
 the word pulls the line low when a character is received at the VSA out

without this signal is always high allowing continued sending of characters

- #1 THESE IC'S MUST BE IN THE SAME PHASE IN ADDRESS, WHERE SHOWN MUST BE USED.
- #2 AN 8251A MAY BE REDWELDED TO RUN AT 1MHz BAND
- #3 RESPONSE PIN MAY BE CONNECTED TO BUS OR TO +5V OR GROUND TO REDUCE PC LAYOUT AS FOLLOWS:
- #4 ▲ INDICATES SOCKETED IC'S

DATE	REV	DESCRIPTION	DATE	APPROVED
SCHEMATIC SIO				
DRAWN BY: J.A.		CHECKED BY: J.A.		DATE: 11/25/80
PARTS LIST		EXTRACT NO.		DATE
DO NOT SCALE DRAWING		SCALE		1/2

until the 280 is at thereby preventing more characters

\*\*\*\* ADVANTAGE TERMINAL EMULATOR DOCUMENTATION \*\*\*\*

t present this program is on an auto start GDOS disk that  
s placed in drive one of the ADVANTEGE computer.

In conjunction with this program a reversing cable and one  
modification to the SIO boardlet in the ADVANTAGE are  
required. The attached sheets document this two items.

Place the diskette with the terminal program in drive one of  
your ADVANTAGE and reset the computer. The program is self  
prompting.

A control shift 2, which sends a null, causes an exit to  
GDOS and as long as GADVTERM which resides at location 0 is  
not overlayed it may be reentered from GDOS by typing JP 0.  
Otherwise it may be invoked by typing GO GADVTERM or by  
resetting the ADVANTAGE.

The emulator allows the user to select the baud rate and to  
determine whether full or half duplex is used.

A 'BREAK' is sent by typing CMND F1.

See Jeff Straus (x309) if there are any questions or  
suggestions for revision.

Number 6  
 Date February 14, 1983  
 Page 1 of 5

Models Affected: ADVANTAGE                      Class of Change: NOT MANDATORY  
 Assembly(s) Affected: ADV MAIN PC BOARD      Field Action: AS REQUIRED  
 Factory Implementation: 11-15-83              Est. Install. Time: 0.5 Hrs.

1. REASON FOR CHANGE

This modification to the ADVANTAGE main PCB will eliminate the half dot shift in the linearity of the lower 2/3 of the ADVANTAGE video screen.

2. DESCRIPTION OF CHANGE

The modification is accomplished by removing L3 (3.3 micro henry coil) located at IC 1A on the main PCB of the ADVANTAGE and replacing it with a 10 ohm 1/4 watt resistor designated R108.

3. REVISION IDENTIFICATION

None

4. REWORK INSTRUCTIONS

A modification and rework instruction sheet is attached to this document.

5. CHECKOUT PROCEDURE

A checkout procedure is attached to this document.

6. TOOLS REQUIRED

Standard soldering tools.

7. PARTS REQUIRED

Resistor: 10 Ohm, 1/4 Watt, 5% Tolerance (North Star Part Number 61053)              Quantity: 1

1—Reason for change    2—Description of change    3—Revision ID    4—Rework instructions    5—Checkout procedure    6—Tools required    7—Parts required    8—Effect on spares    9—Documentation affected    10—Software affected    11—Attachments

APPROVED	DATE	SUPERSEDES	DATED	VERIFIED BY	DATE
<i>Surinder Bawa</i>	2-24-83			<i>P. Johnson</i>	2-23-83

8. EFFECT ON SPARES

None

9. DOCUMENTATION AFFECTED

Schematic, ADVANTAGE Main PCB (North Star Drawing #00100)  
from Revision P to Revision S (copy attached)

10. SOFTWARE AFFECTED

None

11. ATTACHMENTS

Schematic, rework instructions and checkout procedure for  
the ADVANTAGE main PCB are attached.



## REWORK INSTRUCTIONS AND CHECKOUT PROCEDURE

1. Before implementing this modification perform the following test to ensure this change has not already been implemented.
  - A. Boot up an ADVANTAGE Diagnostic/Demonstration diskette 2.0.0 (North Star P/N 00796B).
  - B. Select menu item 3-Diagnostics
  - C. Select menu item 2-Single Block Mode
  - D. Select menu item 5-CRT Test
  - E. An ADVANTAGE requiring modification will exhibit a horizontal half dot shift from row 84 to the bottom of the screen.
2. Disconnect the ADVANTAGE from the AC power source.
3. Remove the top cover of the ADVANTAGE as described in Section 7.3.1 of the ADVANTAGE Technical Manual (North Star P/N 00464C).
4. Using Figure 1 as a reference, desolder L3 (3.3 micro henry inductor) at location IC 1A on the main PC Board.
5. Remove the excess solder from solder pads and holes.
6. Install resistor (North Star P/N 61053) 10 ohm, 1/4 watt, 5% in place of L3.
7. Replace ADVANTAGE top cover as outlined in Section 7.3.1 of the ADVANTAGE Technical Manual.
8. Repeat test as outlined above. Pixel shift should no longer be present.

# MAIN PC BOARD ASSEMBLY

AT LOCATION 1-A

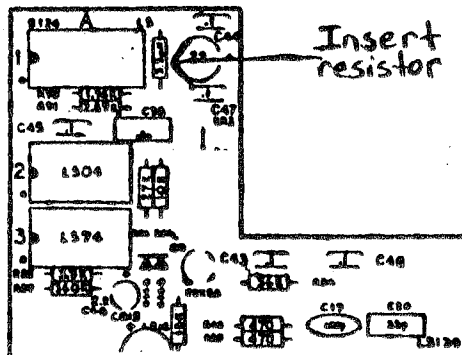

WAS

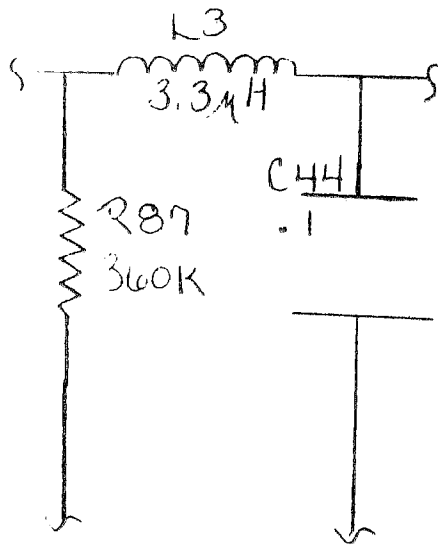

CHANGE TO

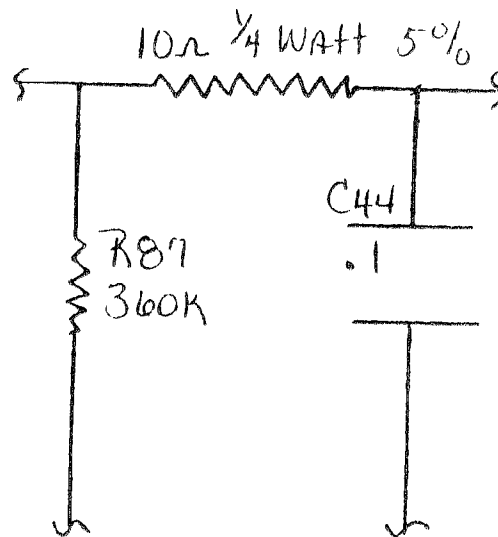
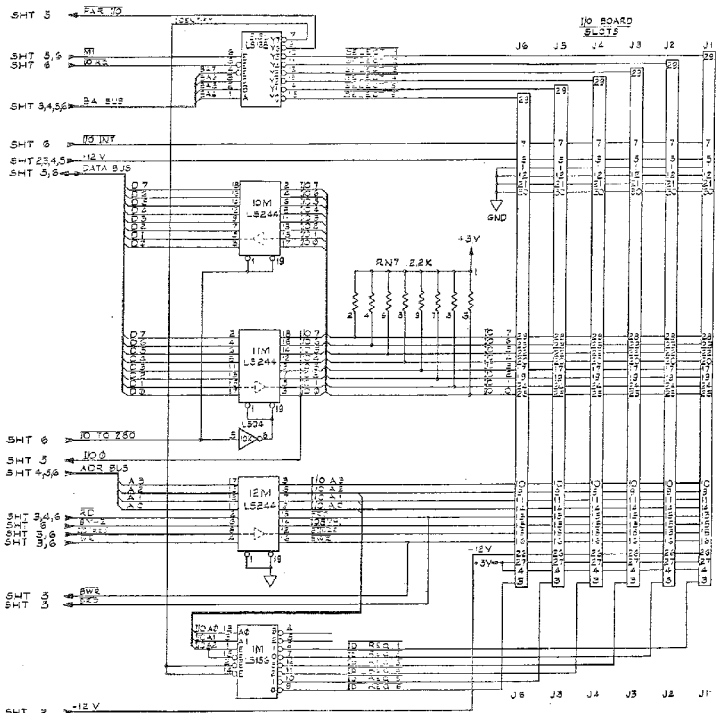
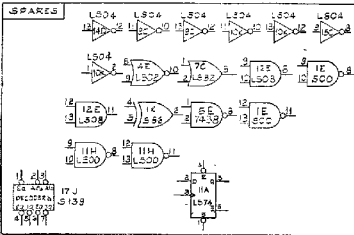

FIGURE 1



- 11. FOR NOTE 11-SEE SMT. 2.
- 12. FOR NOTE 10-SEE SMT. 2.
- 13. 100 AT LOCAT. DA 17E #10 F ARE OMITTED WHEN AN 8048 IS USED AT LOCATION 18C (SEE SMT. 4).
- 14. BYPASS CAPACITOR - CAPAF, 50 V (SEE TOTAL).
- 15. INPUT CHARACTER - 1AF, 16 V (SEE TOTAL).
- 16. FOR NOTE 11-SEE SMT. 2.
- 17. FOR NOTE 10-SEE SMT. 2.
- 18. INDICATED LOCATED 105.
- 19. 4-TEATS 2K REQUIRED.
- 20. ALL CAPACITOR VALUES ARE IN MICROPARADS (μF).
- 21. ALL RESISTOR VALUES ARE IN OHMS (Ω), 1/4W, 1%, 1% ARE METAL FILM, R500D.
- 22. REFERENCE DOCUMENTS: ASSY 1/2 L ARE # 00102.

NOTES: UNLESS OTHERWISE SPECIFIED.

REF	DESCRIPTION	QTY	UNIT	REMARKS
1	LS244	1	IC	
2	LS245	1	IC	
3	LS246	1	IC	
4	LS247	1	IC	
5	LS248	1	IC	
6	LS249	1	IC	
7	LS250	1	IC	
8	LS251	1	IC	
9	LS252	1	IC	
10	LS253	1	IC	
11	LS254	1	IC	
12	LS255	1	IC	
13	LS256	1	IC	
14	LS257	1	IC	
15	LS258	1	IC	
16	LS259	1	IC	
17	LS260	1	IC	
18	LS261	1	IC	
19	LS262	1	IC	
20	LS263	1	IC	
21	LS264	1	IC	
22	LS265	1	IC	
23	LS266	1	IC	
24	LS267	1	IC	
25	LS268	1	IC	
26	LS269	1	IC	
27	LS270	1	IC	
28	LS271	1	IC	
29	LS272	1	IC	
30	LS273	1	IC	
31	LS274	1	IC	
32	LS275	1	IC	
33	LS276	1	IC	
34	LS277	1	IC	
35	LS278	1	IC	
36	LS279	1	IC	
37	LS280	1	IC	
38	LS281	1	IC	
39	LS282	1	IC	
40	LS283	1	IC	
41	LS284	1	IC	
42	LS285	1	IC	
43	LS286	1	IC	
44	LS287	1	IC	
45	LS288	1	IC	
46	LS289	1	IC	
47	LS290	1	IC	
48	LS291	1	IC	
49	LS292	1	IC	
50	LS293	1	IC	
51	LS294	1	IC	
52	LS295	1	IC	
53	LS296	1	IC	
54	LS297	1	IC	
55	LS298	1	IC	
56	LS299	1	IC	
57	LS300	1	IC	

NorthStar  
ADVANTAGE  
MAIN PCB  
SS-57410

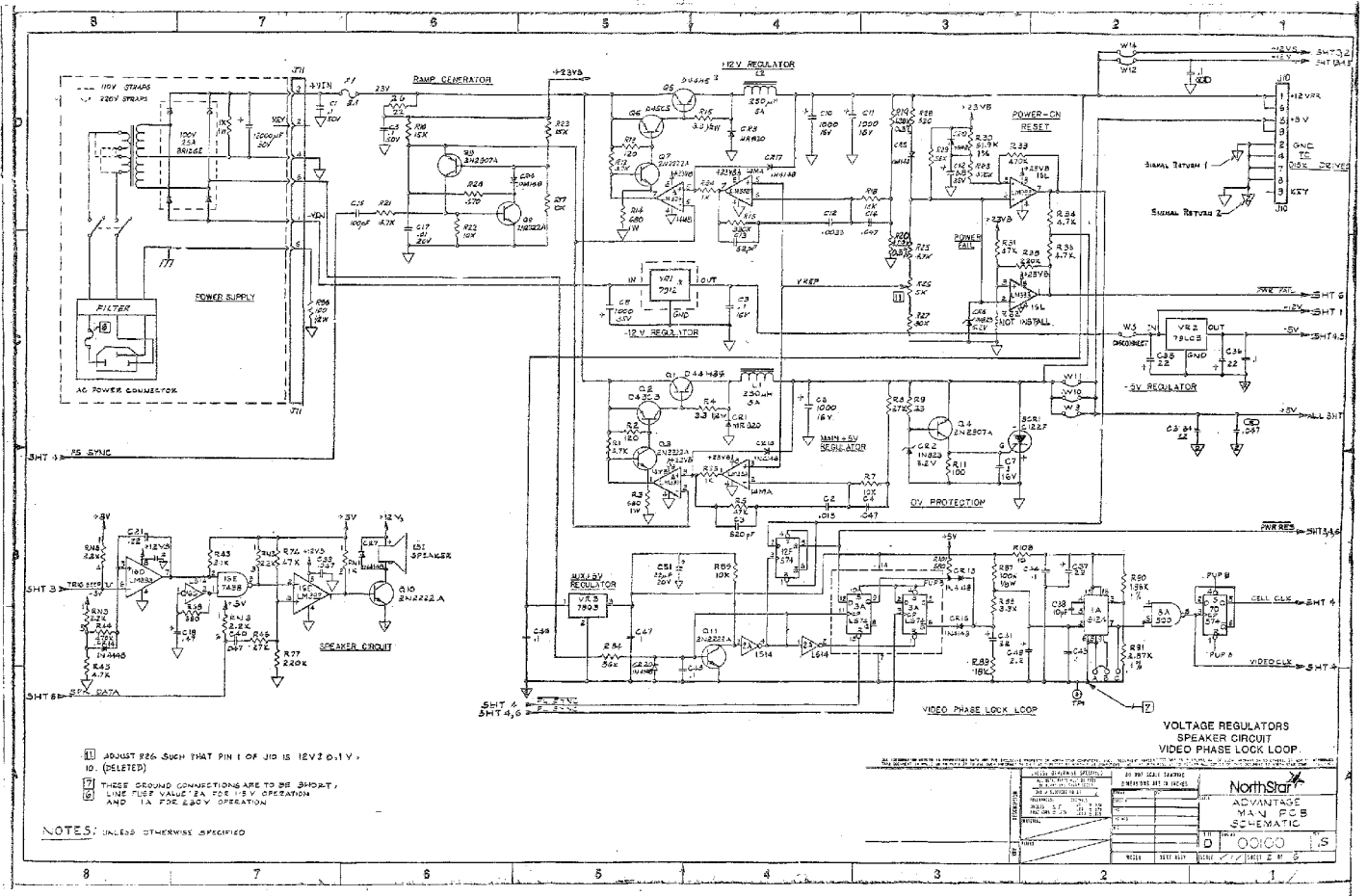

- 1] ADJUST R26 SUCH THAT PIN 1 OF J10 IS 12V2 0.1V. 10. (DELETED)
- 2] THESE GROUND CONNECTIONS ARE TO BE SHORTED. LINE TUBE VALUE EA FOR 15V OPERATION AND 1A FOR 50V OPERATION

NOTES: UNLESS OTHERWISE SPECIFIED

TITLE		DATE		BY		CHECKED	
VOLTAGE REGULATORS SPEAKER CIRCUIT VIDEO PHASE LOCK LOOP							
<p>NorthStar</p> <p>ADVANTAGE MAN PCB SCHEMATIC</p>				<p>1.5</p>			
REVISION		DATE		BY		CHECKED	
1							

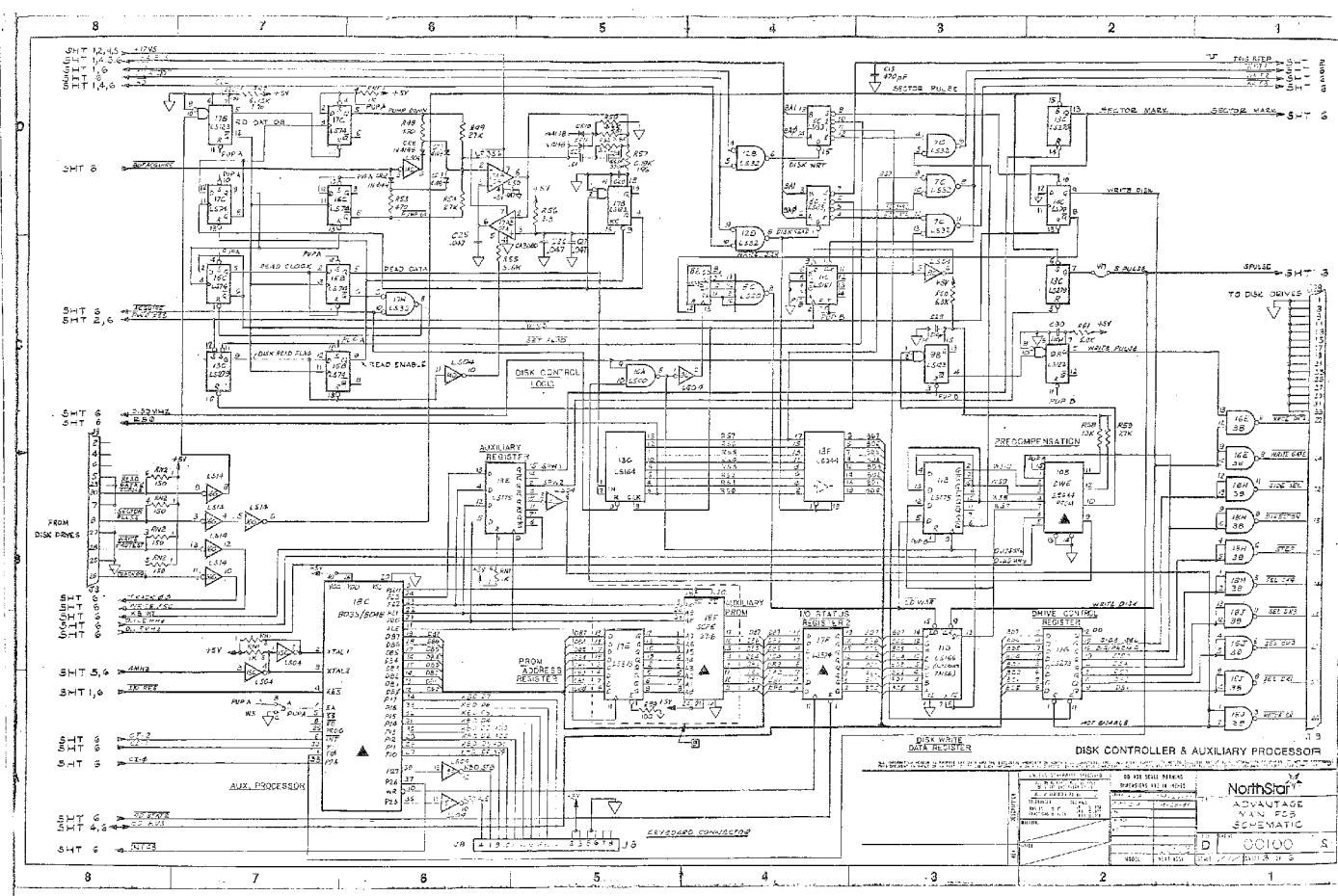

NorthStar  
 ADVANTAGE  
 VAN PCB  
 SCHEMATIC

REV.	DATE	BY	CHKD.	APP.
1				
2				
3				
4				
5				
6				
7				
8				
9				
10				

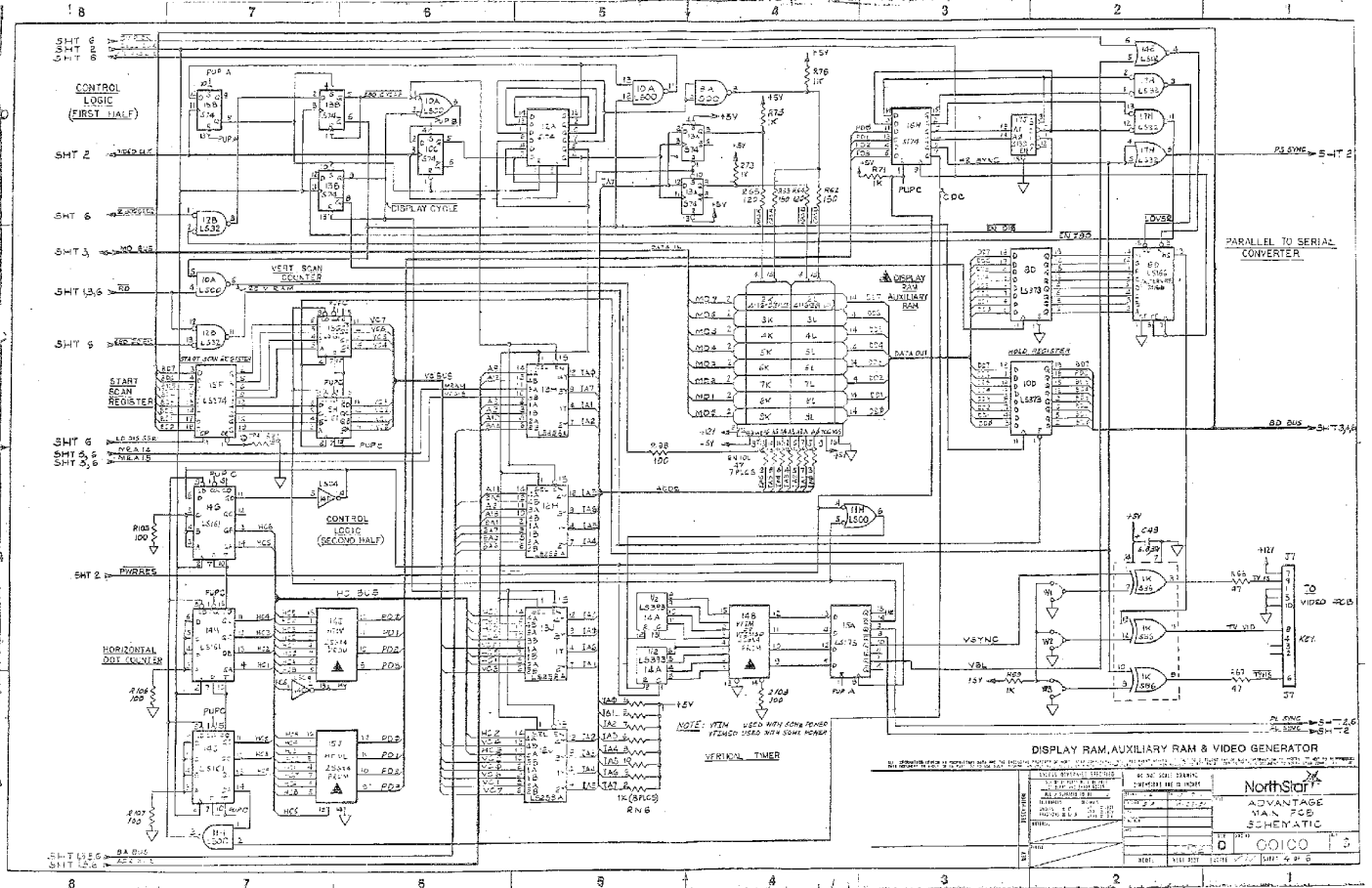

**DISPLAY RAM, AUXILIARY RAM & VIDEO GENERATOR**  
 NORTHSTAR ADVANTAGE  
 MAIN PCB SCHEMATIC  
 DATE: 11/11/88  
 DRAWN BY: J. J. [unreadable]  
 CHECKED BY: [unreadable]  
 APPROVED BY: [unreadable]

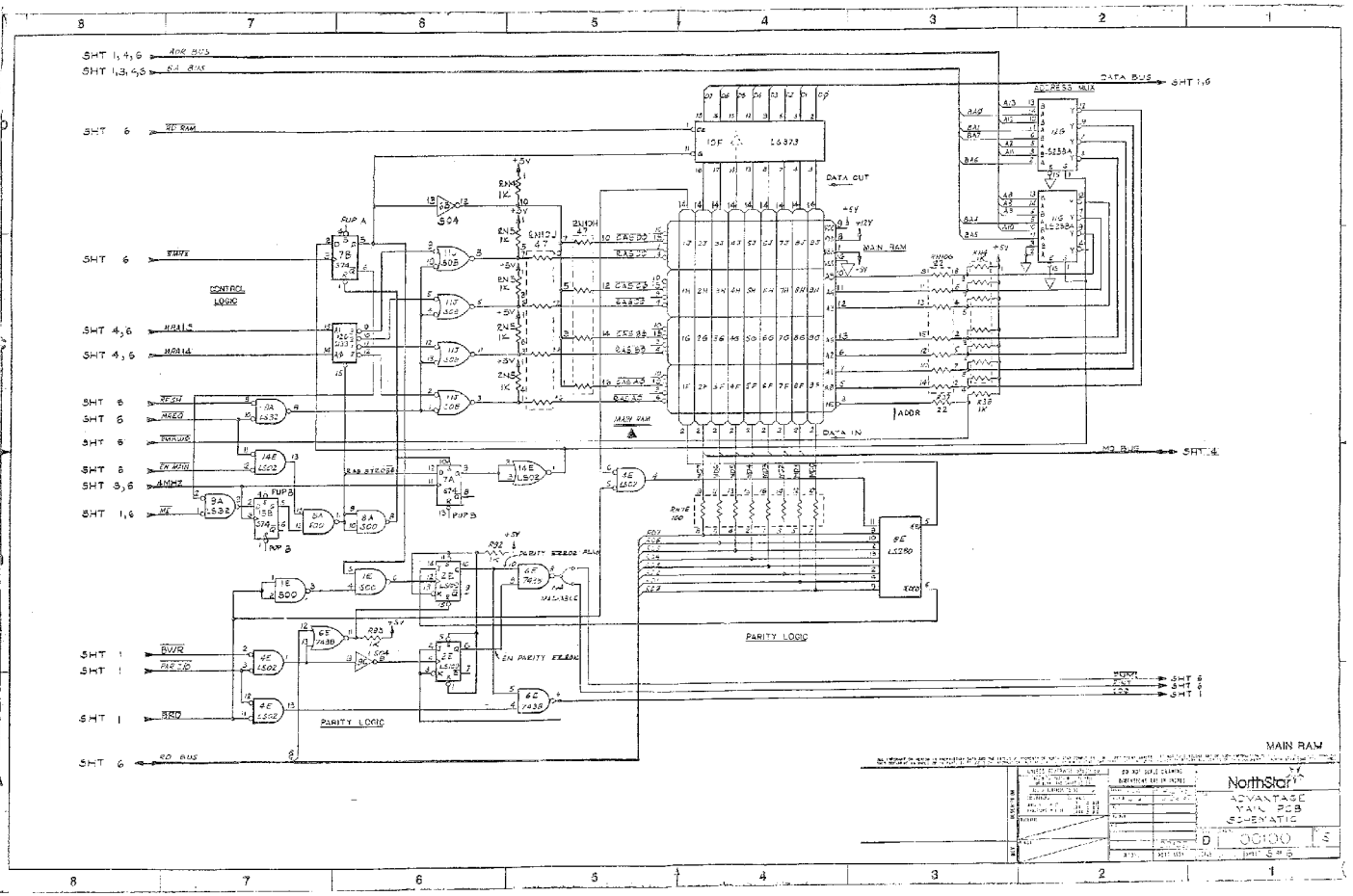

REV		DATE		BY	
1					
2					
3					
4					
5					
6					
7					
8					

APPROVED		DATE		BY	
1					
2					
3					
4					
5					
6					
7					
8					

**NorthStar**  
 ADVANTAGE  
 VAX PCB  
 SCHEMATIC  
 00000  
 10/10/80

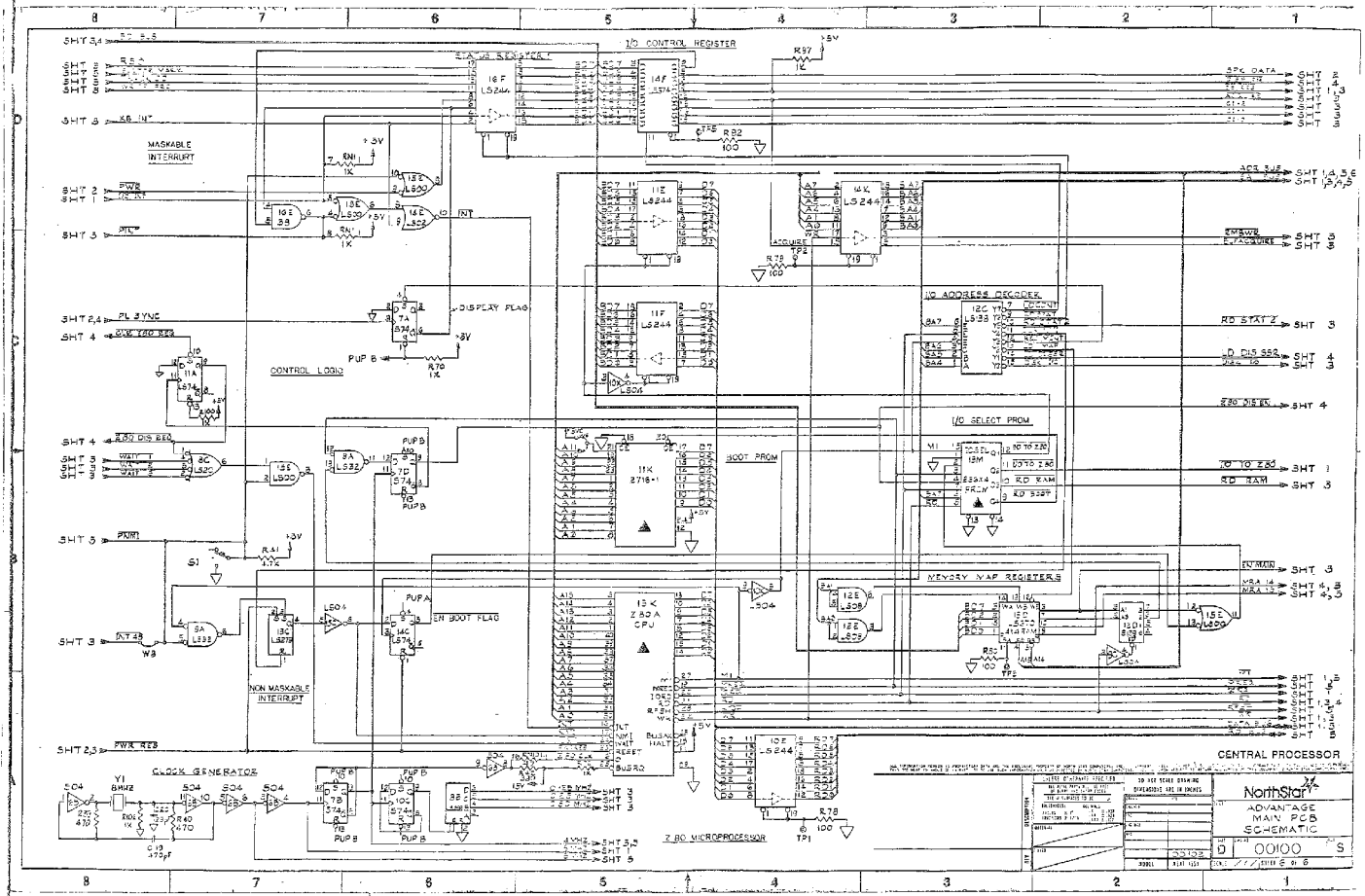

CENTRAL PROCESSOR

NO.	QTY	DESIGNATION	REMARKS
1	1	Z80A	CPU
2	1	2716-1	EPROM
3	2	6264	RAM
4	2	74LS244	Buffer
5	2	74LS158	Decoder
6	2	74LS04	Inverter
7	1	74LS147	Decoder
8	1	74LS138	Decoder
9	1	74LS139	Decoder
10	1	74LS160	Counter
11	1	74LS161	Counter
12	1	74LS162	Counter
13	1	74LS163	Counter
14	1	74LS164	Shift Register
15	1	74LS165	Shift Register
16	1	74LS166	Shift Register
17	1	74LS167	Shift Register
18	1	74LS168	Shift Register
19	1	74LS169	Shift Register
20	1	74LS170	Shift Register
21	1	74LS171	Shift Register
22	1	74LS172	Shift Register
23	1	74LS173	Shift Register
24	1	74LS174	Shift Register
25	1	74LS175	Shift Register
26	1	74LS176	Shift Register
27	1	74LS177	Shift Register
28	1	74LS178	Shift Register
29	1	74LS179	Shift Register

NonStar  
ADVANTAGE  
MAIN PCB  
SCHEMATIC

DATE: 01/00/91

REV: 00